

SECTION **PG**

POWER SUPPLY, GROUND & CIRCUIT ELEMENTS

CONTENTS

PRECAUTION	3	Wiring Diagram - ACCESSORY POWER SUPPLY -	25	A
PRECAUTIONS	3	Wiring Diagram - ACCESSORY POWER SUPPLY FUSE No. 18 -	26	B
Precaution for Supplemental Restraint System (SRS) "AIR BAG" and "SEAT BELT PRE-TENSIONER"	3	Wiring Diagram - IGNITION POWER SUPPLY -	27	C
Precaution for Procedure without Cowl Top Cover.....	3	Wiring Diagram - IGNITION POWER SUPPLY FUSE No. 3 -	31	D
PREPARATION	4	Wiring Diagram - IGNITION POWER SUPPLY FUSE No. 4 -	33	E
PREPARATION	4	Wiring Diagram - IGNITION POWER SUPPLY FUSE No. 44 -	34	F
Special Service Tools	4	Wiring Diagram - IGNITION POWER SUPPLY FUSE No. 46 -	35	G
SYSTEM DESCRIPTION	5	OPTION HARNESS	36	H
COMPONENT PARTS	5	Wiring Diagram	36	I
Circuit Breaker	5	FUSE BLOCK - JUNCTION BOX (J/B)	37	J
Battery	5	Fuse, Connector and Terminal Arrangement	37	K
Harness Connector	5	FUSE, FUSIBLE LINK AND RELAY BOX	38	L
Standardized Relay	8	Fuse and Fusible Link Arrangement	38	
WIRING DIAGRAM	11	IPDM E/R (INTELLIGENT POWER DISTRIBUTION MODULE ENGINE ROOM)	39	PG
POWER SUPPLY ROUTING CIRCUIT	11	Fuse, Connector and Terminal Arrangement	39	
Wiring Diagram - BATTERY POWER SUPPLY -	11	PCB HARNESS	40	N
Wiring Diagram - BATTERY POWER SUPPLY FUSIBLE LINK No. L -	15	Connector and Terminal Arrangement	40	
Wiring Diagram - BATTERY POWER SUPPLY FUSE No. 6 -	16	HARNESS LAYOUT	41	O
Wiring Diagram - BATTERY POWER SUPPLY FUSE No. 7 -	17	How To Read Harness Layout	41	
Wiring Diagram - BATTERY POWER SUPPLY FUSE No. 9 -	18	Engine Room Harness	42	P
Wiring Diagram - BATTERY POWER SUPPLY FUSE No. 11 -	19	Engine Control Harness	43	
Wiring Diagram - BATTERY POWER SUPPLY FUSE No. 34 -	20	Main Harness	48	
Wiring Diagram - BATTERY POWER SUPPLY FUSE No. 51 -	21	Body Harness	49	
Wiring Diagram - BATTERY POWER SUPPLY FUSE No. 53 -	23	Door Harness	51	
		Room Lamp Harness	55	
		Tail Harness	56	
		CONNECTOR INFORMATION	57	
		How to Read Connector Type	57	

B Body Harness	58	How To Check	141
D Door Harness	77	REMOVAL AND INSTALLATION	142
E Engine Room Harness	84	BATTERY	142
F Engine Control Harness	93	Exploded View	142
M Main Harness	106	Removal and Installation	142
R Room Lamp Harness	131	BATTERY TERMINAL WITH FUSIBLE LINK..	143
T Tail Harness	134	Exploded View	143
BASIC INSPECTION	135	Removal and Installation	143
BATTERY INSPECTION	135	SERVICE DATA AND SPECIFICATIONS	
How to Handle Battery	135	(SDS)	144
Work Flow	135	SERVICE DATA AND SPECIFICATIONS	
FUSE INSPECTION	138	(SDS)	144
How To Check	138	Battery	144
FUSIBLE LINK INSPECTION	141		

PRECAUTIONS

< PRECAUTION >

PRECAUTION

PRECAUTIONS

Precaution for Supplemental Restraint System (SRS) "AIR BAG" and "SEAT BELT PRE-TENSIONER"

INFOID:000000008131308

The Supplemental Restraint System such as "AIR BAG" and "SEAT BELT PRE-TENSIONER", used along with a front seat belt, helps to reduce the risk or severity of injury to the driver and front passenger for certain types of collision. This system includes seat belt switch inputs and dual stage front air bag modules. The SRS system uses the seat belt switches to determine the front air bag deployment, and may only deploy one front air bag, depending on the severity of a collision and whether the front occupants are belted or unbelted. Information necessary to service the system safely is included in the "SRS AIR BAG" and "SEAT BELT" of this Service Manual.

WARNING:

Always observe the following items for preventing accidental activation.

- To avoid rendering the SRS inoperative, which could increase the risk of personal injury or death in the event of a collision that would result in air bag inflation, all maintenance must be performed by an authorized NISSAN/INFINITI dealer.
- Improper maintenance, including incorrect removal and installation of the SRS, can lead to personal injury caused by unintentional activation of the system. For removal of Spiral Cable and Air Bag Module, see "SRS AIR BAG".
- Never use electrical test equipment on any circuit related to the SRS unless instructed to in this Service Manual. SRS wiring harnesses can be identified by yellow and/or orange harnesses or harness connectors.

PRECAUTIONS WHEN USING POWER TOOLS (AIR OR ELECTRIC) AND HAMMERS

WARNING:

Always observe the following items for preventing accidental activation.

- When working near the Air Bag Diagnosis Sensor Unit or other Air Bag System sensors with the ignition ON or engine running, never use air or electric power tools or strike near the sensor(s) with a hammer. Heavy vibration could activate the sensor(s) and deploy the air bag(s), possibly causing serious injury.
- When using air or electric power tools or hammers, always switch the ignition OFF, disconnect the battery, and wait at least 3 minutes before performing any service.

Precaution for Procedure without Cowl Top Cover

INFOID:000000008131309

When performing the procedure after removing cowl top cover, cover the lower end of windshield with urethane, etc to prevent damage to windshield.



PREPARATION

< PREPARATION >

PREPARATION

PREPARATION

Special Service Tools

INFOID:000000008131310

Tool number (Kent-Moore No.) Tool name	Description
— (—) Model GR8-1200 NI Multitasking battery and electrical diagnostic station	Tests batteries, starting and charging systems and charges batteries. For operating instructions, refer to diagnostic station instruction manual.
— (—) Model EXP-800 NI Battery and electrical diagnostic analyzer	Tests batteries and charging systems. For operating instructions, refer to diagnostic analyzer instruction manual.

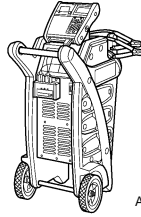

AWIIA1239ZZ

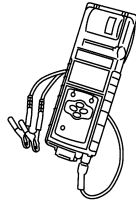

JSMIA0806ZZ

COMPONENT PARTS

< SYSTEM DESCRIPTION >

SYSTEM DESCRIPTION

COMPONENT PARTS

Circuit Breaker

INFOID:000000008131311

The PTC thermistor generates heat in response to current flow. The temperature (and resistance) of the thermistor element varies with current flow. Excessive current flow will cause the element's temperature to rise. When the temperature reaches a specified level, the electrical resistance will rise sharply to control the circuit current. Reduced current flow will cause the element to cool. Resistance falls accordingly and normal circuit current flow is allowed to resume.

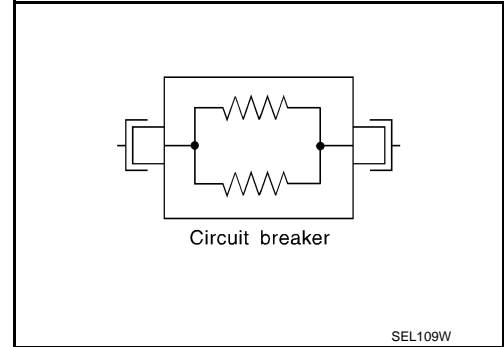

Battery

INFOID:000000008131312

Application	VQ37VHR engine models	VK56VD engine models
Type	110D26L-HR*	110D26L-HP*
20 hour rate capacity [V - Ah]	12 - 75	12 - 75
Cold cranking current (For reference value) [A]	720	720

HR* and HP*: Because of the frequent battery charge/discharge performed according to a driving condition and a battery condition, this model uses a charge/discharge capacity-enhanced battery. Therefore, it is recommended to use a genuine battery when replacement is needed.

Harness Connector

INFOID:000000008131313

HARNESS CONNECTOR (TAB-LOCKING TYPE)

- The tab-locking type connectors help prevent accidental looseness or disconnection.
- The tab-locking type connectors are disconnected by pushing or lifting the locking tab(s). Refer to the figure below.

CAUTION:

Never pull the harness or wires when disconnecting the connector.

A
B
C
D
E
F
G
H
I
J
K
L
N
O
P

PG

COMPONENT PARTS

< SYSTEM DESCRIPTION >

[Example]

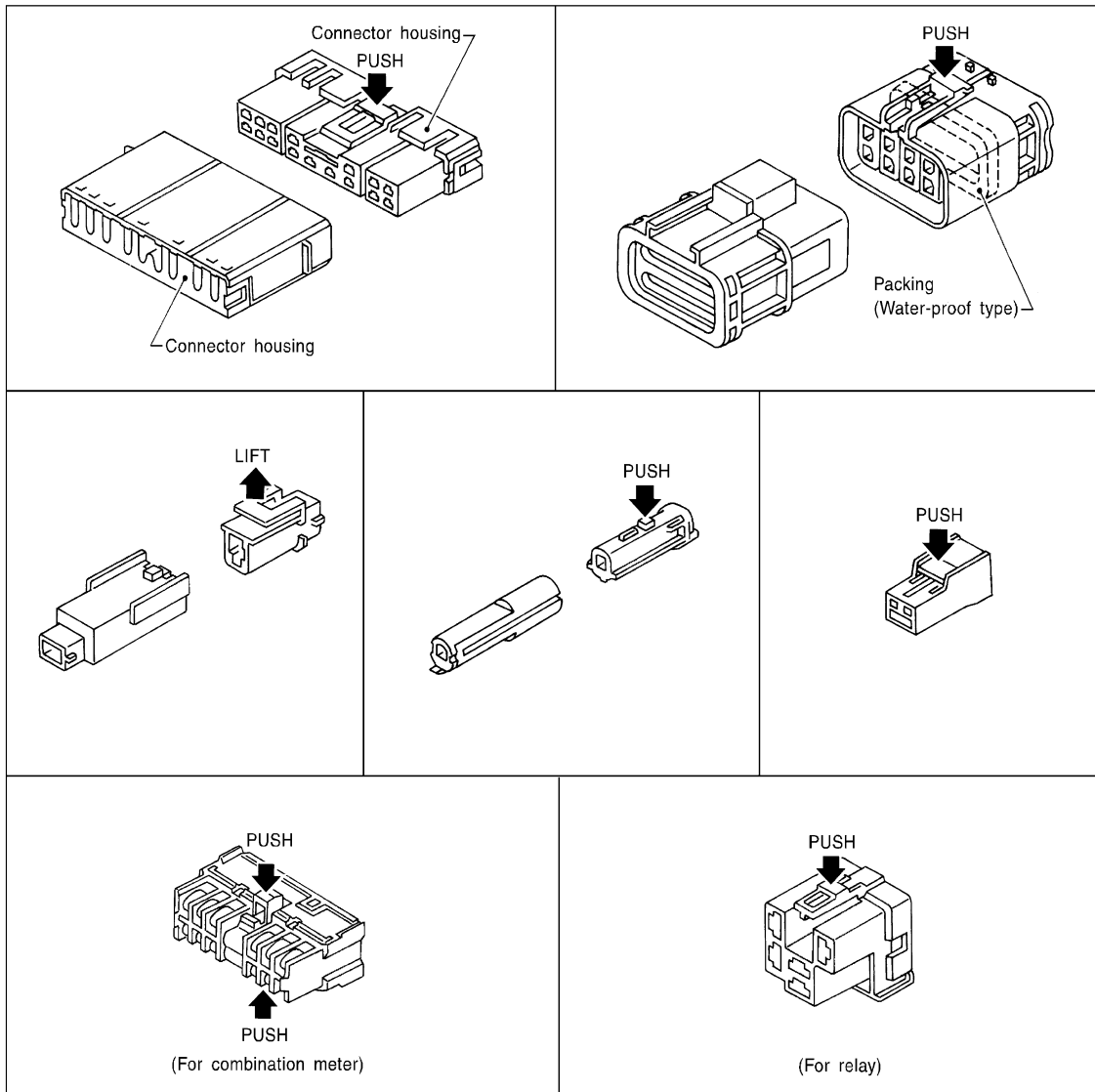

SEL769DA

HARNESS CONNECTOR (SLIDE-LOCKING TYPE)

- A new style slide-locking type connector is used on certain systems and components, especially those related to OBD.
- The slide-locking type connectors help prevent incomplete locking and accidental looseness or disconnection.
- The slide-locking type connectors are disconnected by pushing or pulling the slider. Refer to the figure below.

CAUTION:

- **Never pull the harness or wires when disconnecting the connector.**
- **Be careful not to damage the connector support bracket when disconnecting the connector.**

COMPONENT PARTS

< SYSTEM DESCRIPTION >

[Example]

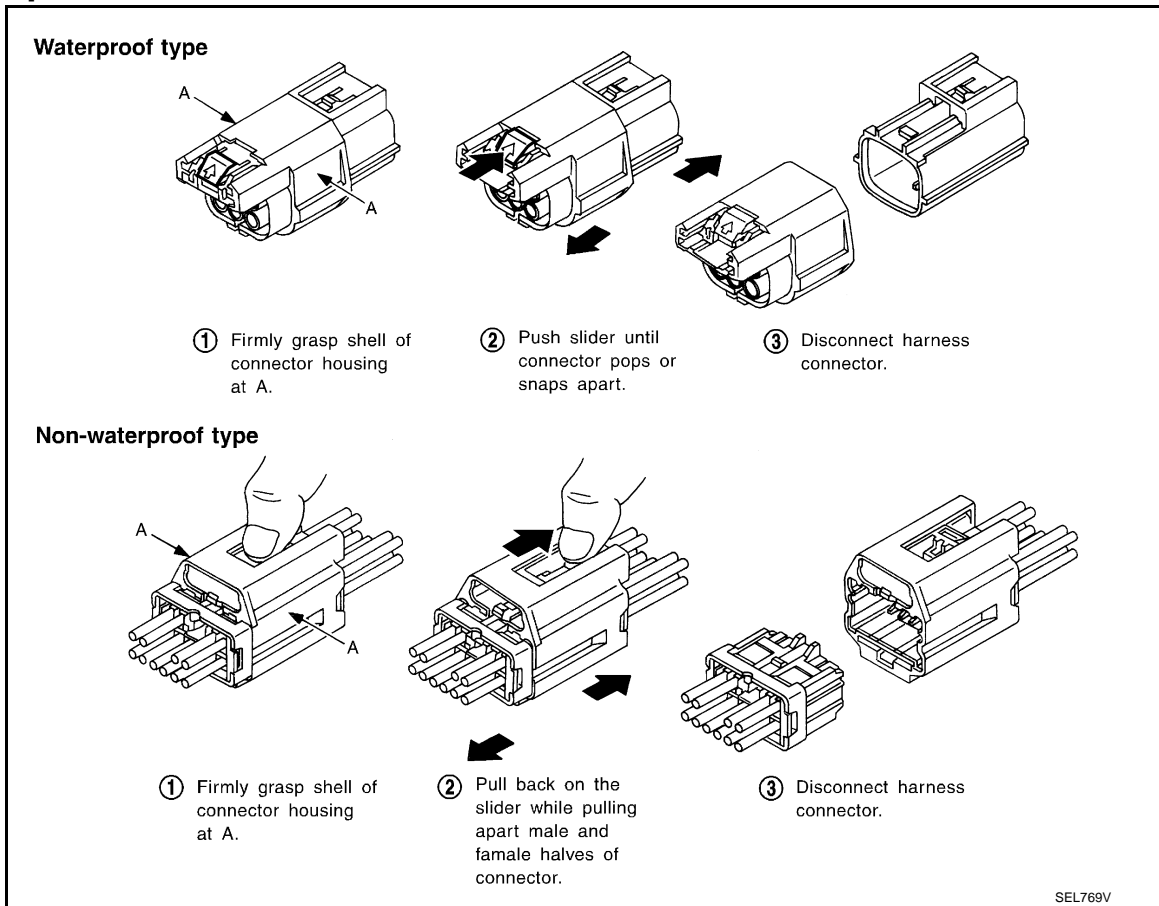

HARNESS CONNECTOR (LEVER LOCKING TYPE)

- Lever locking type harness connectors are used on certain control units and control modules such as ECM, ABS actuator and electric unit (control unit), etc.
- Lever locking type harness connectors are also used on super multiple junction (SMJ) connectors.
- Always confirm the lever is fully locked in place by moving the lever as far as it will go to ensure full connection.

CAUTION:

A
B
C
D
E
F
G
H
I
J
K
L

PG

N
O
P

COMPONENT PARTS

< SYSTEM DESCRIPTION >

Always confirm the lever is fully released (loosened) before attempting to disconnect or connect these connectors to avoid damage to the connector housing or terminals.

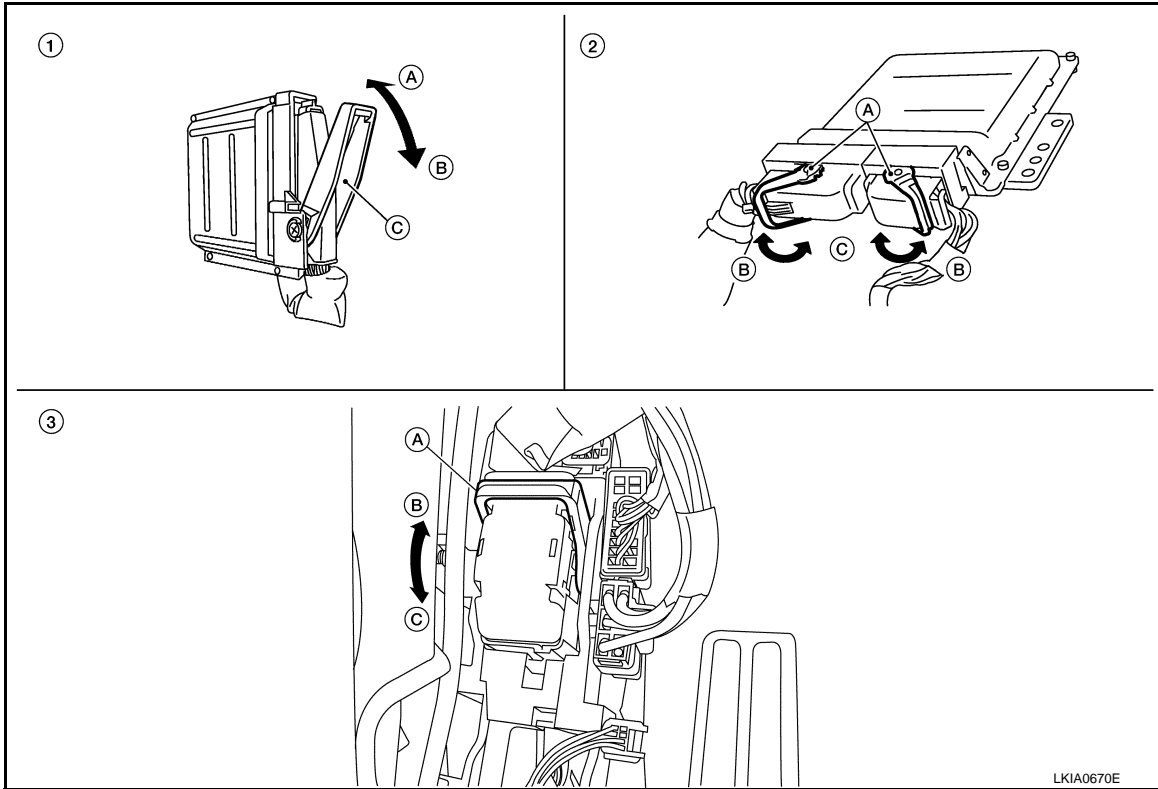

- | | | |
|-----------------------------------|----------------------------------|------------------|
| 1. Control unit with single lever | 2. Control unit with dual levers | 3. SMJ connector |
| A. Fasten | A. Levers | A. Lever |
| B. Loosen | B. Fasten | B. Fasten |
| C. Lever | C. Loosen | C. Loosen |

Standardized Relay

INFOID:000000008131314

NORMAL OPEN, NORMAL CLOSED AND MIXED TYPE RELAYS

Relays can mainly be divided into three types: normal open, normal closed and mixed type relays.

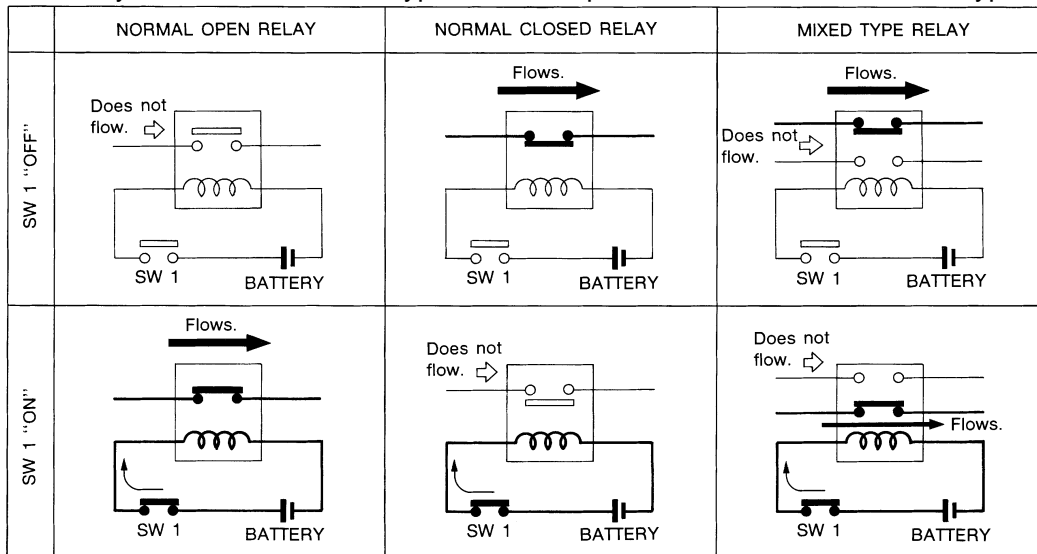

SEL881H

TYPE OF STANDARDIZED RELAYS

COMPONENT PARTS

< SYSTEM DESCRIPTION >

1M 1 Make 2M 2 Make
 1T 1 Transfer 1M·1B 1 Make 1 Break

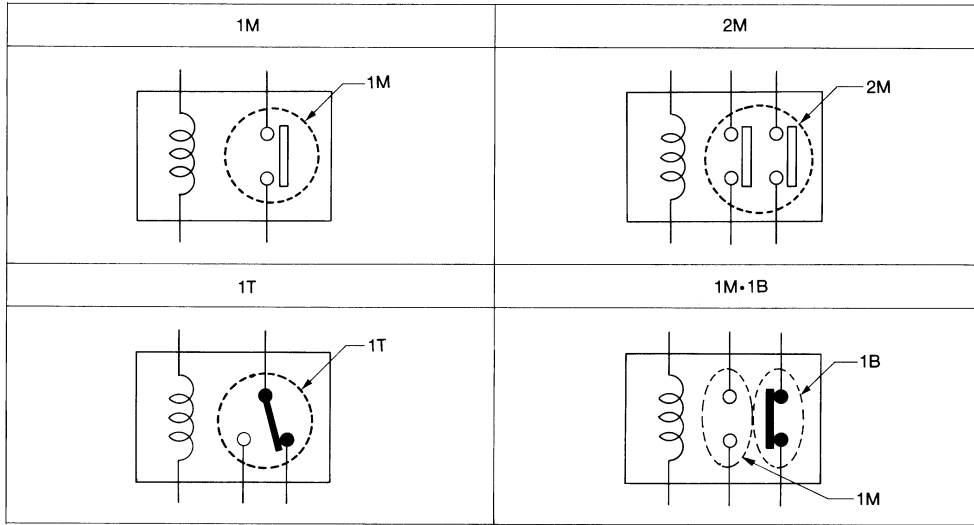

SEL882H

A
B
C
D
E
F
G
H
I
J
K
L
PG
N
O
P

COMPONENT PARTS

< SYSTEM DESCRIPTION >

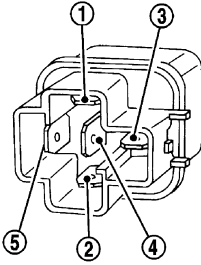
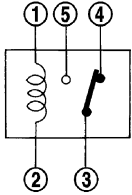
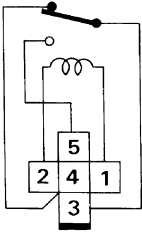
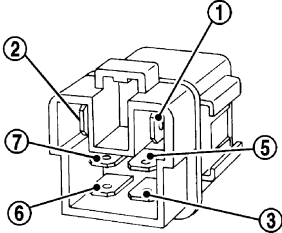
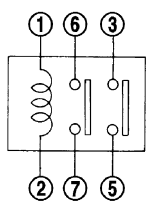
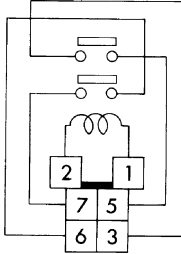
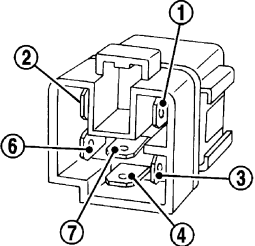
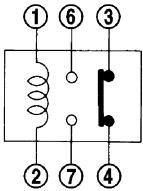
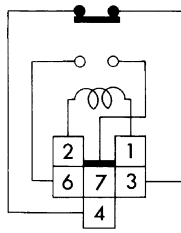
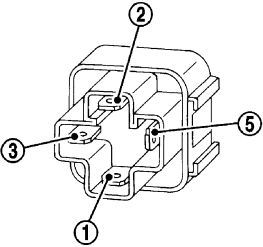
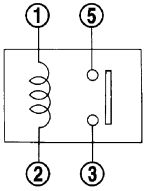
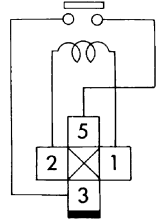
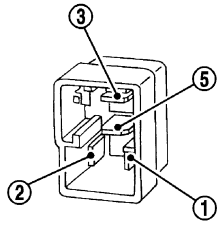
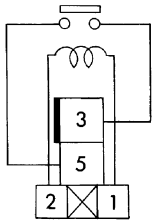
Type	Outer view	Circuit	Connector symbol and connection	Case color
1T				BLACK
2M				BROWN
1M*1B				GRAY
1M				BLUE
				

The arrangement of terminal numbers on the actual relays may differ from those shown above.

SEL188W

POWER SUPPLY ROUTING CIRCUIT

< WIRING DIAGRAM >

WIRING DIAGRAM

POWER SUPPLY ROUTING CIRCUIT

Wiring Diagram - BATTERY POWER SUPPLY -

INFOID:000000008131315

For connector terminal arrangements, harness layouts, and alphabets in a  (option abbreviation; if not described in wiring diagram), refer to [GI-12. "Connector Information"](#).

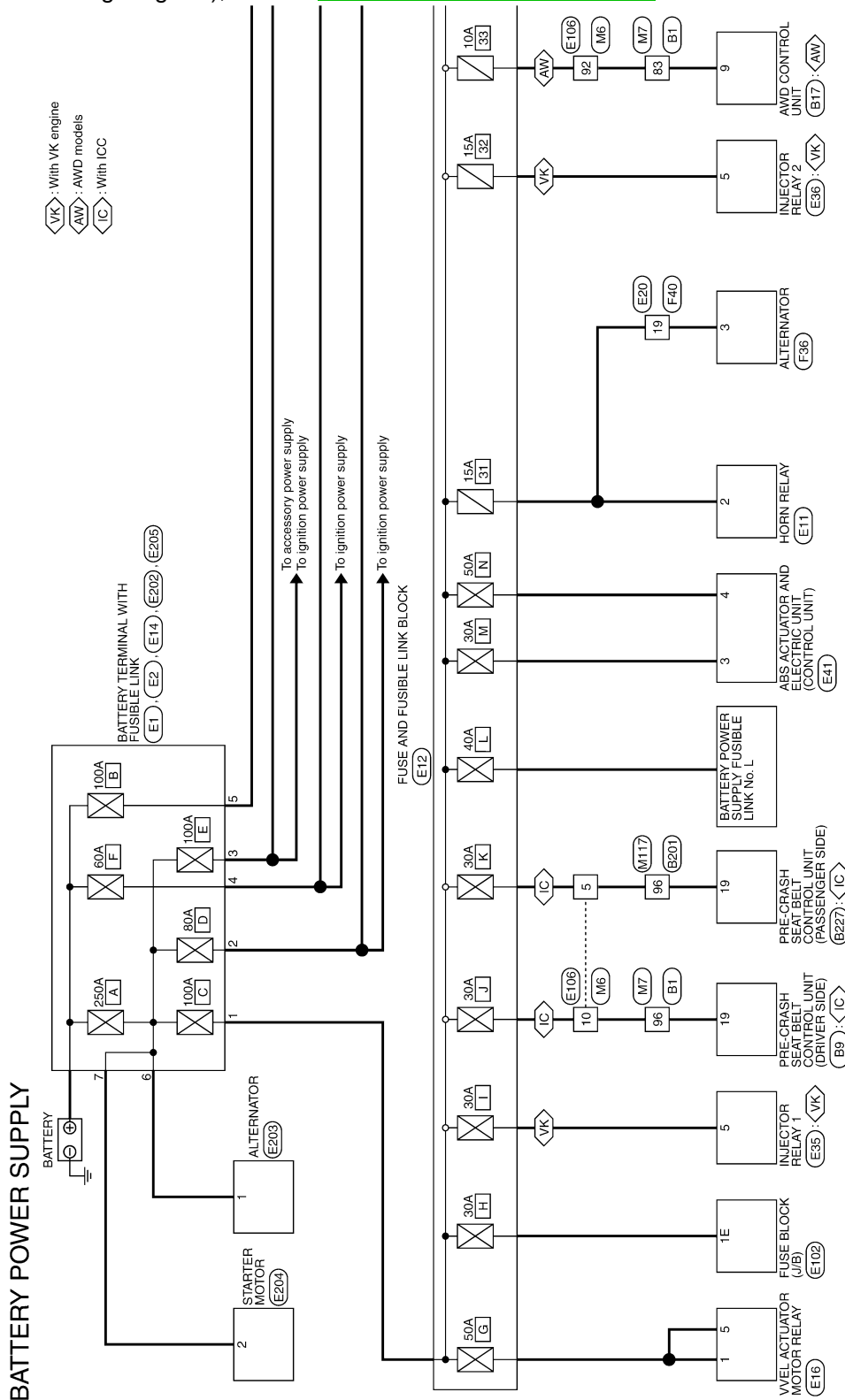

2012/02/27

JRMWC9505GB

A
B
C
D
E
F
G
H
I
J
K
L
N
O
P

PG

POWER SUPPLY ROUTING CIRCUIT

< WIRING DIAGRAM >

- <VK> : With VK engine
- <IC> : With ICC
- <4S> : With 4WAS
- <WC> : With climate controlled seat
- <HS> : With heated seat

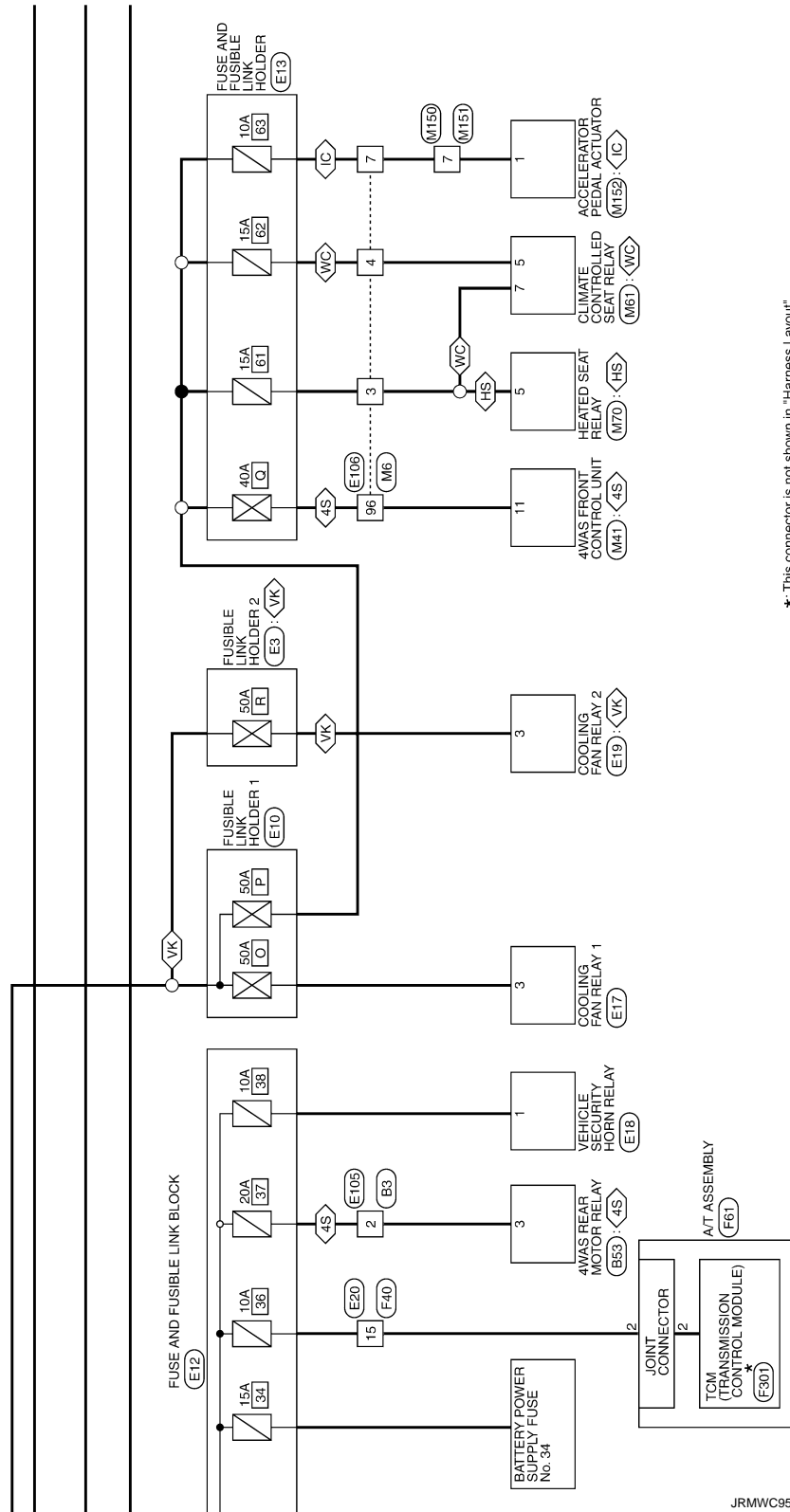

*: This connector is not shown in "Harness Layout".

JRMWC9506GB

POWER SUPPLY ROUTING CIRCUIT

< WIRING DIAGRAM >

WB : With BOSE system
SS : With heated steering

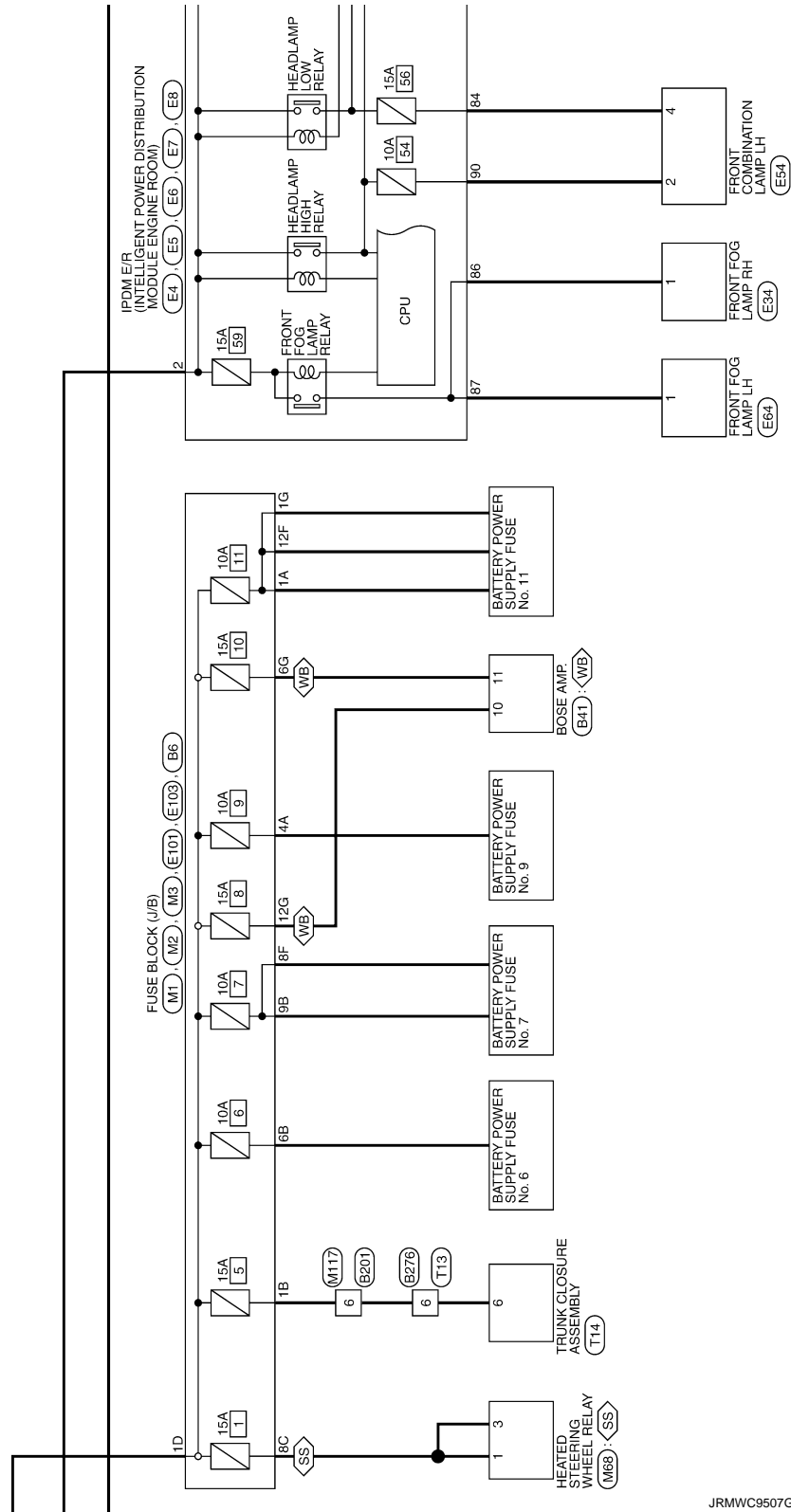

JRMWC9507GB

A
B
C
D
E
F
G
H
I
J
K
L
PG
N
O
P

POWER SUPPLY ROUTING CIRCUIT

< WIRING DIAGRAM >

◊VK◊ : With VK engine
 ◊VQ◊ : With VQ engine

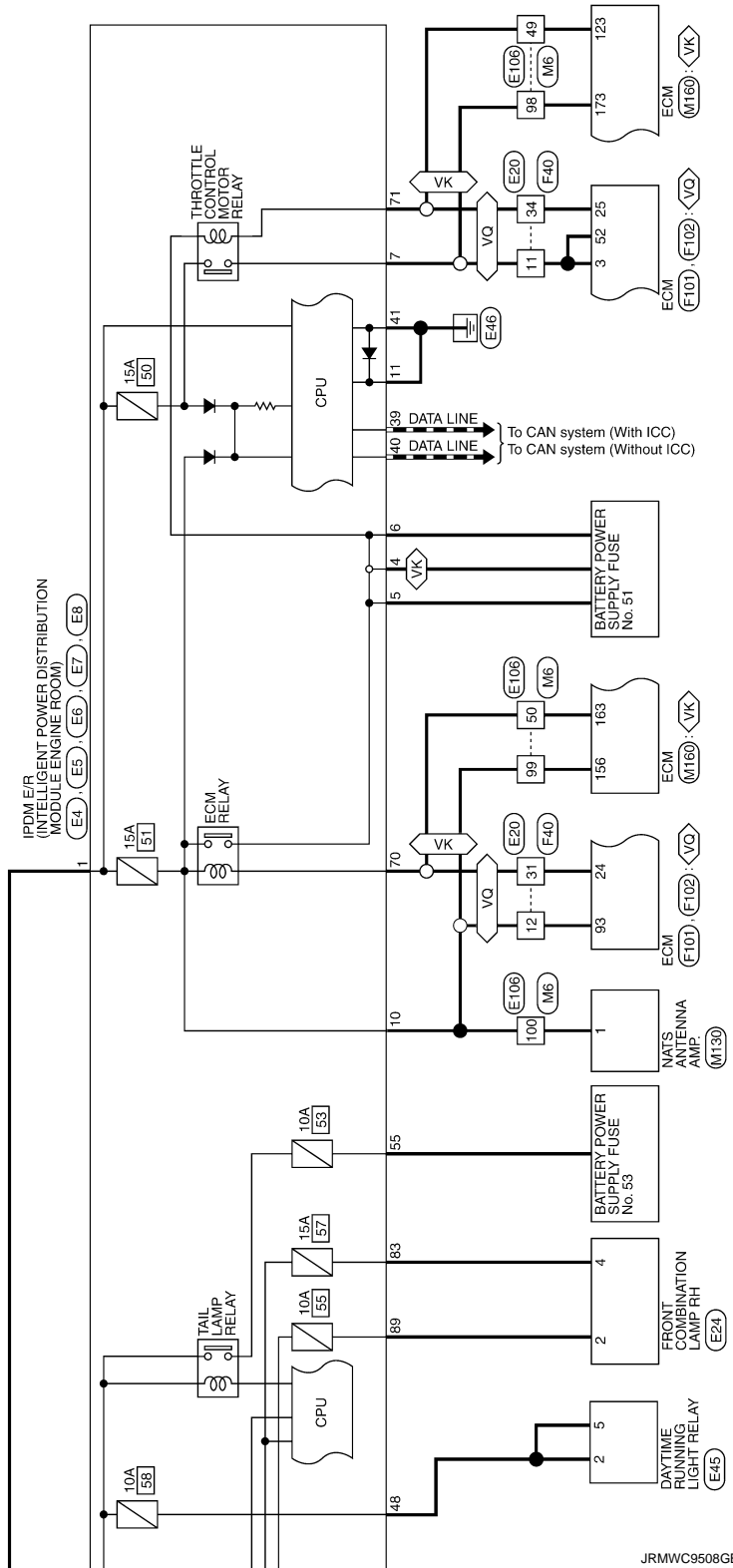

JRMWC9508GB

POWER SUPPLY ROUTING CIRCUIT

< WIRING DIAGRAM >

Wiring Diagram - BATTERY POWER SUPPLY FUSIBLE LINK No. L -

INFOID:000000008131316

For connector terminal arrangements, harness layouts, and alphabets in a  (option abbreviation; if not described in wiring diagram), refer to [GI-12, "Connector Information"](#).

BATTERY POWER SUPPLY FUSIBLE LINK No. L

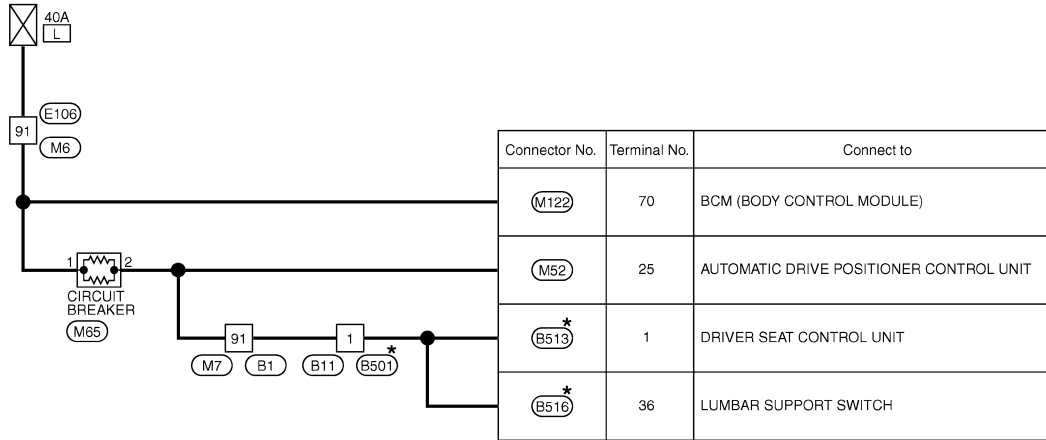

* : This connector is not shown in "Harness Layout".

2010/02/03

JCMWA5605GB

A
B
C
D
E
F
G
H
I
J
K
L
N
O
P

PG

POWER SUPPLY ROUTING CIRCUIT

< WIRING DIAGRAM >

Wiring Diagram - BATTERY POWER SUPPLY FUSE No. 6 -

INFOID:000000008131317

For connector terminal arrangements, harness layouts, and alphabets in a  (option abbreviation; if not described in wiring diagram), refer to [GI-12, "Connector Information"](#).

BATTERY POWER SUPPLY FUSE No. 6

 : With ICC

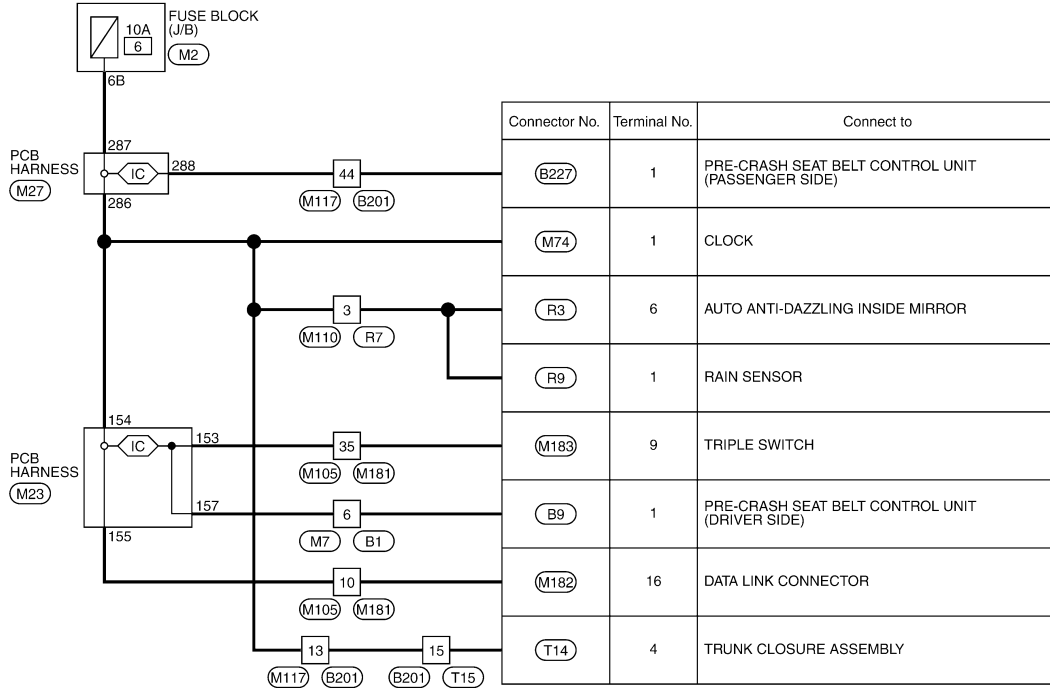

2012/02/27

JRMWC9509GB

POWER SUPPLY ROUTING CIRCUIT

< WIRING DIAGRAM >

Wiring Diagram - BATTERY POWER SUPPLY FUSE No. 7 -

INFOID:000000008131318

For connector terminal arrangements, harness layouts, and alphabets in a  (option abbreviation; if not described in wiring diagram), refer to [GI-12, "Connector Information"](#).

BATTERY POWER SUPPLY FUSE No. 7

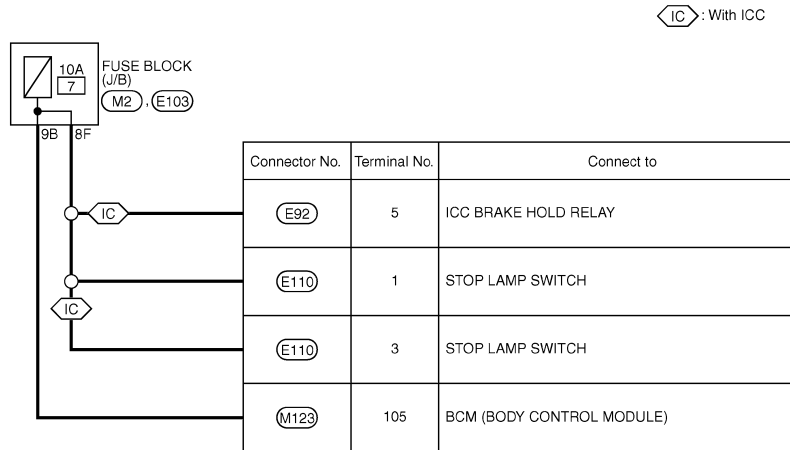

2010/02/03

JCMWA5615GB

A
B
C
D
E
F
G
H
I
J
K
L
N
O
P

PG

POWER SUPPLY ROUTING CIRCUIT

< WIRING DIAGRAM >

Wiring Diagram - BATTERY POWER SUPPLY FUSE No. 9 -

INFOID:000000008131319

For connector terminal arrangements, harness layouts, and alphabets in a  (option abbreviation; if not described in wiring diagram), refer to [GI-12, "Connector Information"](#).

BATTERY POWER SUPPLY FUSE No. 9

 : AWD models

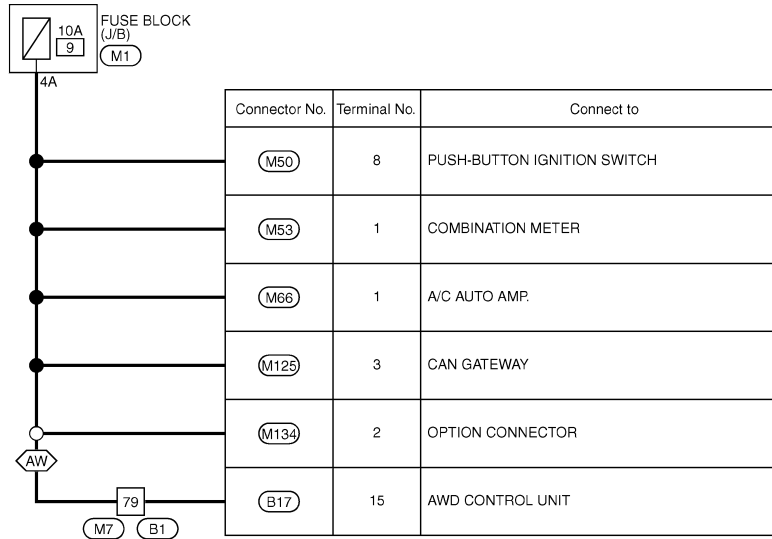

2010/12/14

JCMWA7365GB

POWER SUPPLY ROUTING CIRCUIT

< WIRING DIAGRAM >

Wiring Diagram - BATTERY POWER SUPPLY FUSE No. 11 -

INFOID:000000008131320

For connector terminal arrangements, harness layouts, and alphabets in a  (option abbreviation; if not described in wiring diagram), refer to [GI-12, "Connector Information"](#).

BATTERY POWER SUPPLY FUSE No. 11

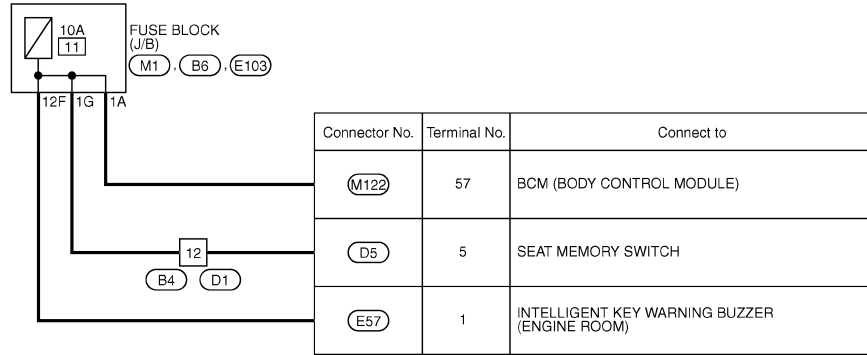

A
B
C
D
E
F
G
H
I
J
K
L

PG

N
O
P

2010/02/03

JCMWA5621GB

POWER SUPPLY ROUTING CIRCUIT

< WIRING DIAGRAM >



Wiring Diagram - BATTERY POWER SUPPLY FUSE No. 34 -

INFOID:000000008131321

For connector terminal arrangements, harness layouts, and alphabets in a  (option abbreviation; if not described in wiring diagram), refer to [GI-12, "Connector Information"](#).

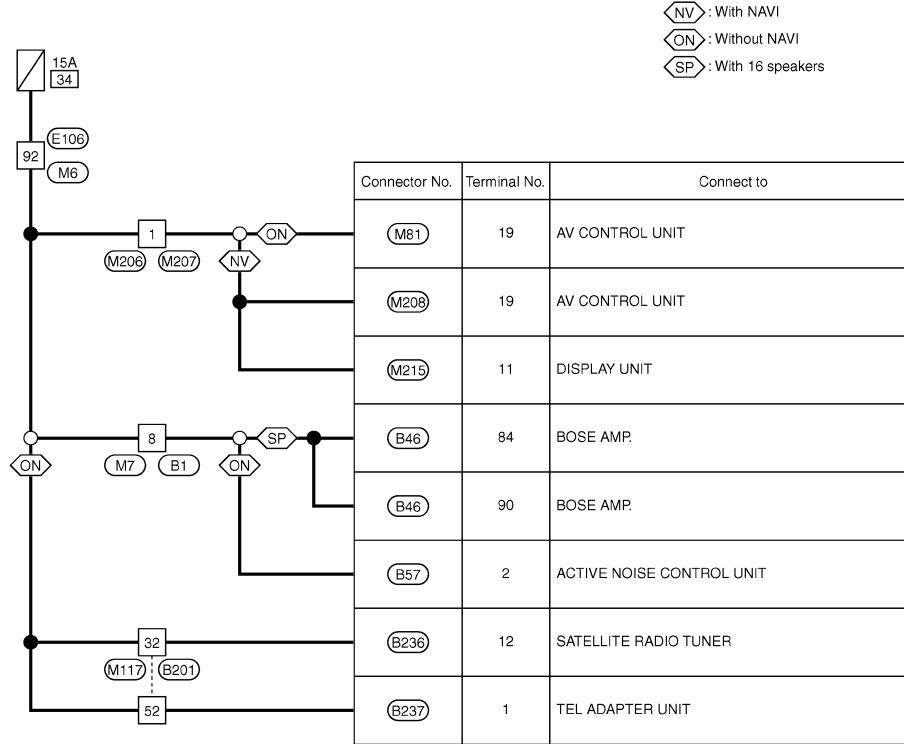
BATTERY POWER SUPPLY FUSE No. 34



 : With NAVI
 : Without NAVI
 : With 16 speakers

2010/02/03

JCMWA5624GB

POWER SUPPLY ROUTING CIRCUIT

< WIRING DIAGRAM >

Wiring Diagram - BATTERY POWER SUPPLY FUSE No. 51 -

INFOID:000000008131322

For connector terminal arrangements, harness layouts, and alphabets in a  (option abbreviation; if not described in wiring diagram), refer to [GI-12, "Connector Information"](#).

BATTERY POWER SUPPLY FUSE No. 51

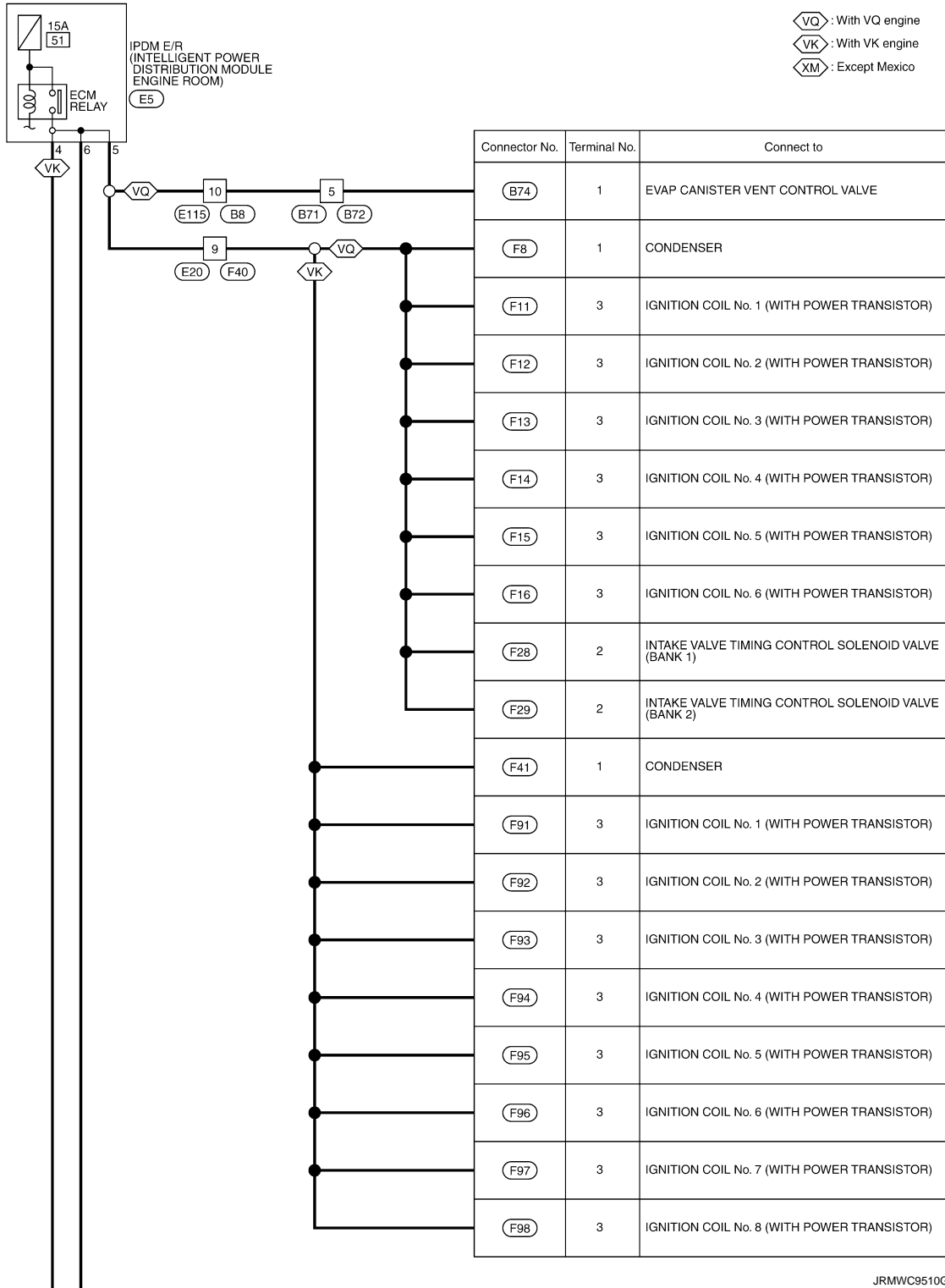

JRMWC9510GB

A
B
C
D
E
F
G
H
I
J
K
L
N
O
P

PG

POWER SUPPLY ROUTING CIRCUIT

< WIRING DIAGRAM >

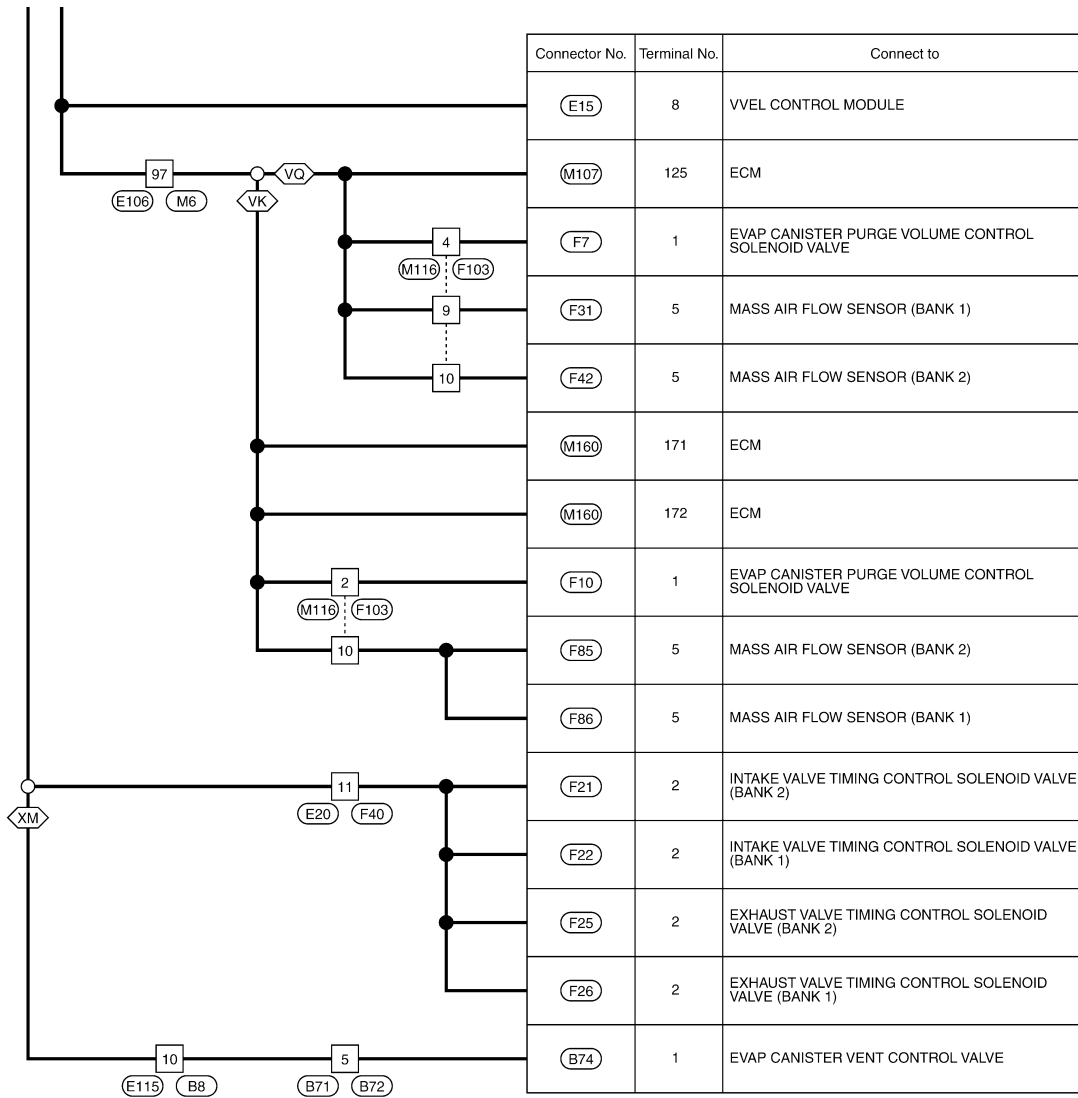

2012/02/27

JRMWC9511GB

POWER SUPPLY ROUTING CIRCUIT





< WIRING DIAGRAM >

Wiring Diagram - BATTERY POWER SUPPLY FUSE No. 53 -

INFOID:000000008131323

For connector terminal arrangements, harness layouts, and alphabets in a  (option abbreviation; if not described in wiring diagram), refer to [GI-12, "Connector Information"](#).

BATTERY POWER SUPPLY FUSE No. 53

-  : With heated seat
-  : With climate controlled seat
-  : With ICC
-  : With heated steering
-  : With NAVI

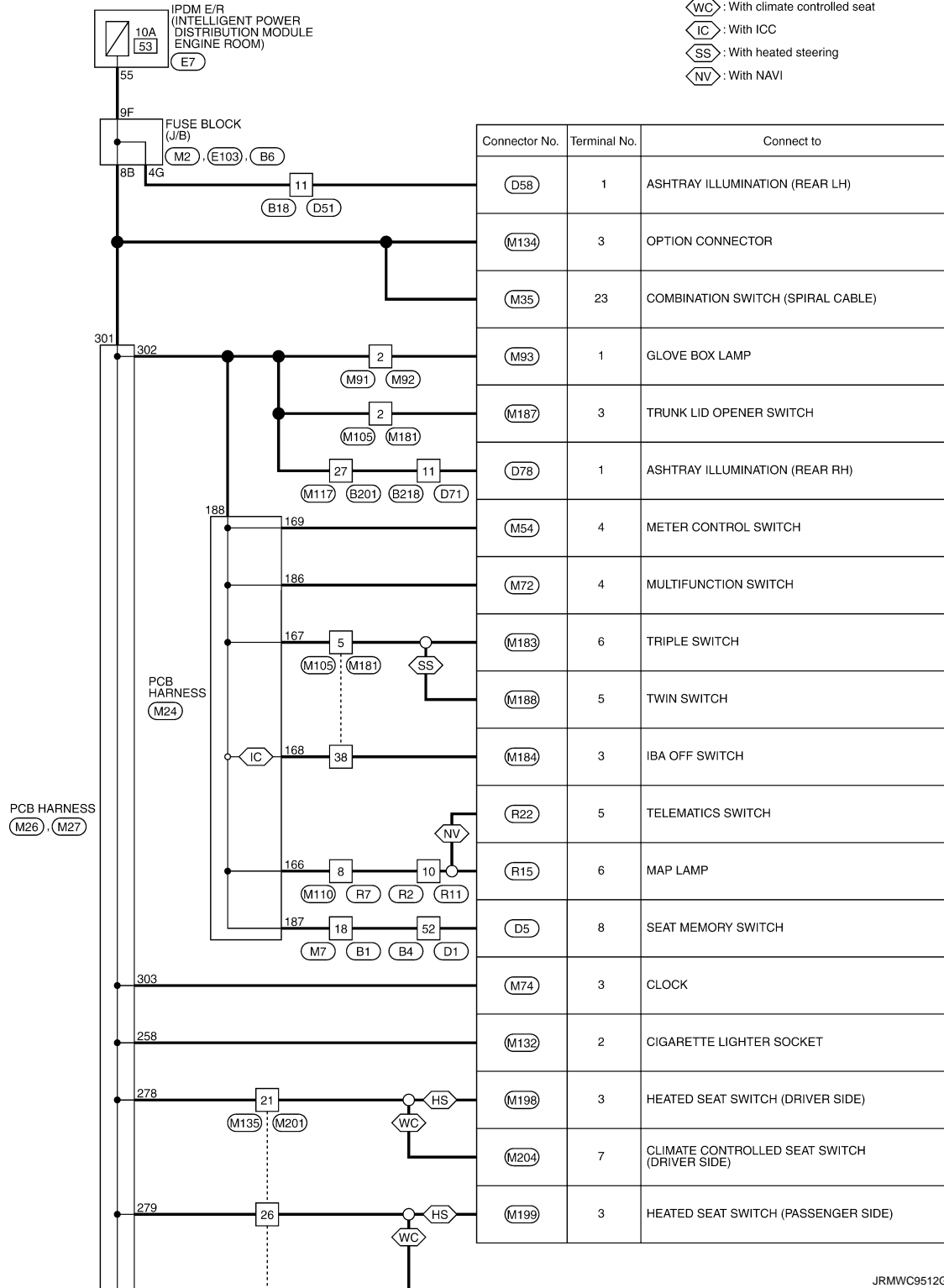

JRMWC9512GB

A
B
C
D
E
F
G
H
I
J
K
L
PG
N
O
P

PG

POWER SUPPLY ROUTING CIRCUIT

< WIRING DIAGRAM >

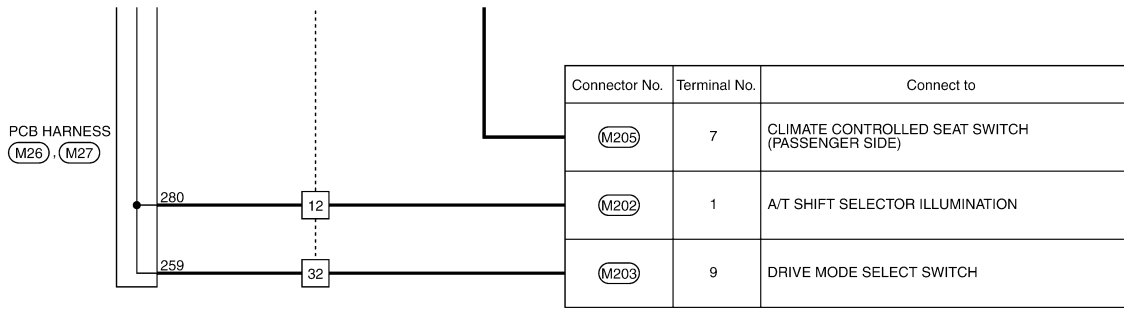

2012/02/27

JRMWC9513GB

POWER SUPPLY ROUTING CIRCUIT

< WIRING DIAGRAM >

Wiring Diagram - ACCESSORY POWER SUPPLY -

INFOID:000000008131324

For connector terminal arrangements, harness layouts, and alphabets in a  (option abbreviation; if not described in wiring diagram), refer to [GI-12, "Connector Information"](#).

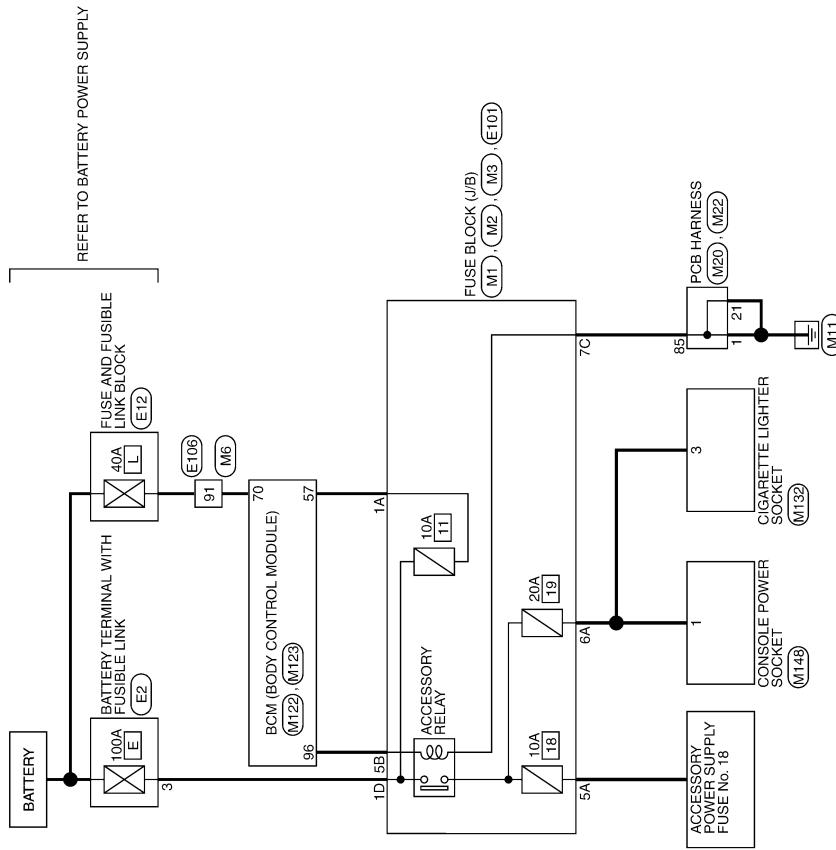

ACCESSORY POWER SUPPLY

2012/02/27

JRMWC9514GB

A
B
C
D
E
F
G
H
I
J
K
L
N
O
P

PG

POWER SUPPLY ROUTING CIRCUIT



< WIRING DIAGRAM >

Wiring Diagram - ACCESSORY POWER SUPPLY FUSE No. 18 -

INFOID:000000008131325

For connector terminal arrangements, harness layouts, and alphabets in a  (option abbreviation; if not described in wiring diagram), refer to [GI-12, "Connector Information"](#).

ACCESSORY POWER SUPPLY FUSE No. 18

 : With NAVI
 : Without NAVI

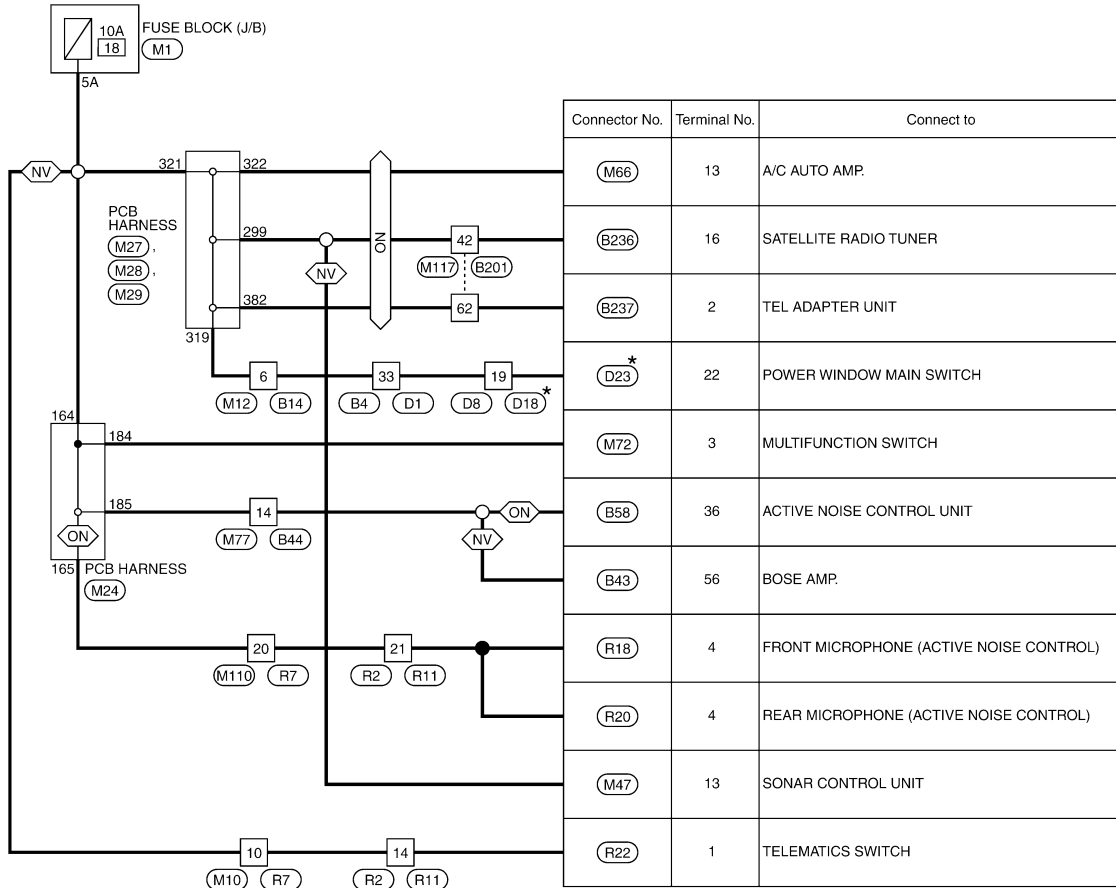

*: This connector is not shown in "Harness Layout".

2012/02/27

JRMWC9515GB

POWER SUPPLY ROUTING CIRCUIT

< WIRING DIAGRAM >

Wiring Diagram - IGNITION POWER SUPPLY -

INFOID:000000008131326

For connector terminal arrangements, harness layouts, and alphabets in a  (option abbreviation; if not described in wiring diagram), refer to [GI-12, "Connector Information"](#).

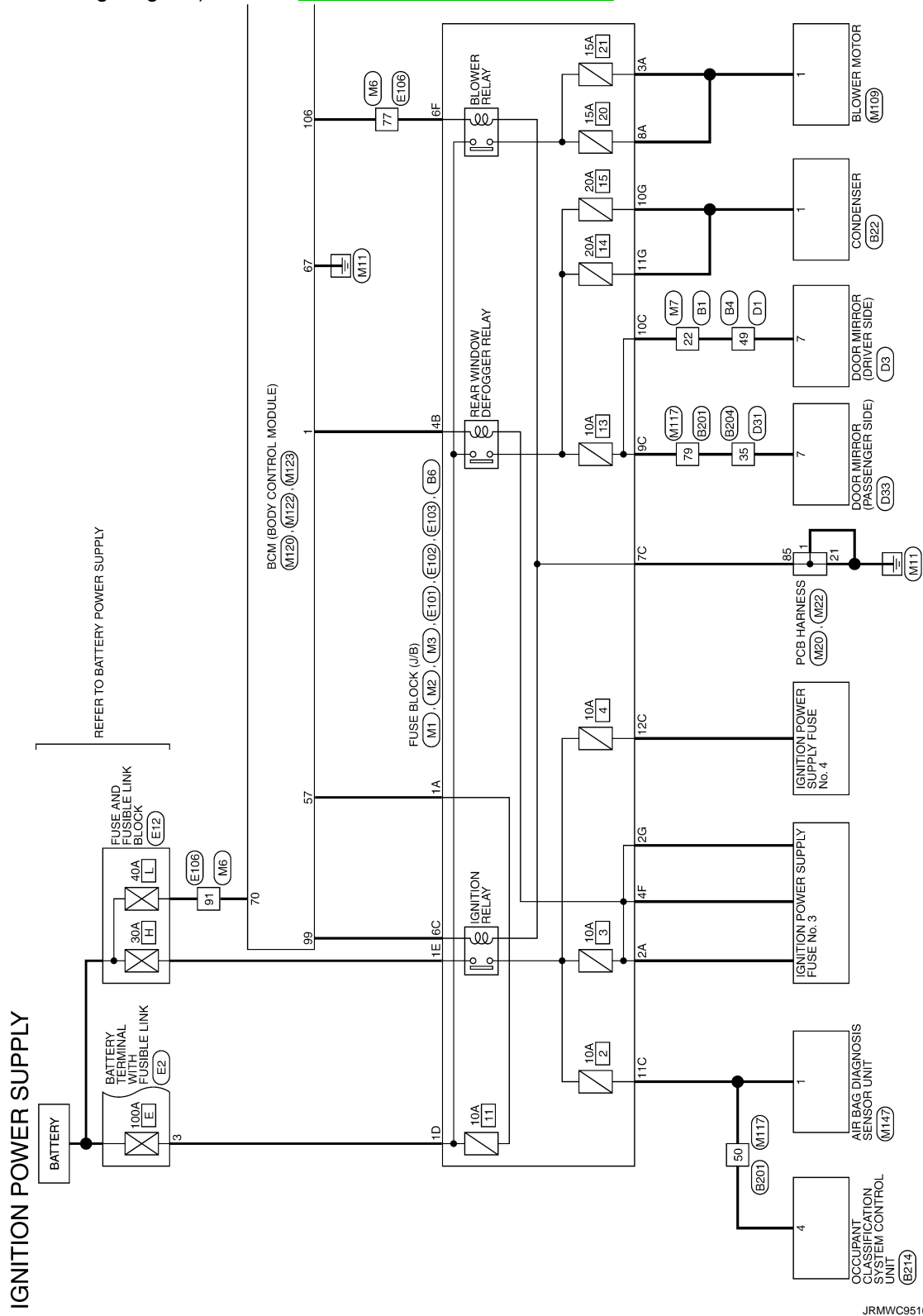

A
B
C
D
E
F
G
H
I
J
K
L
M
N
O
P

PG

POWER SUPPLY ROUTING CIRCUIT

< WIRING DIAGRAM >

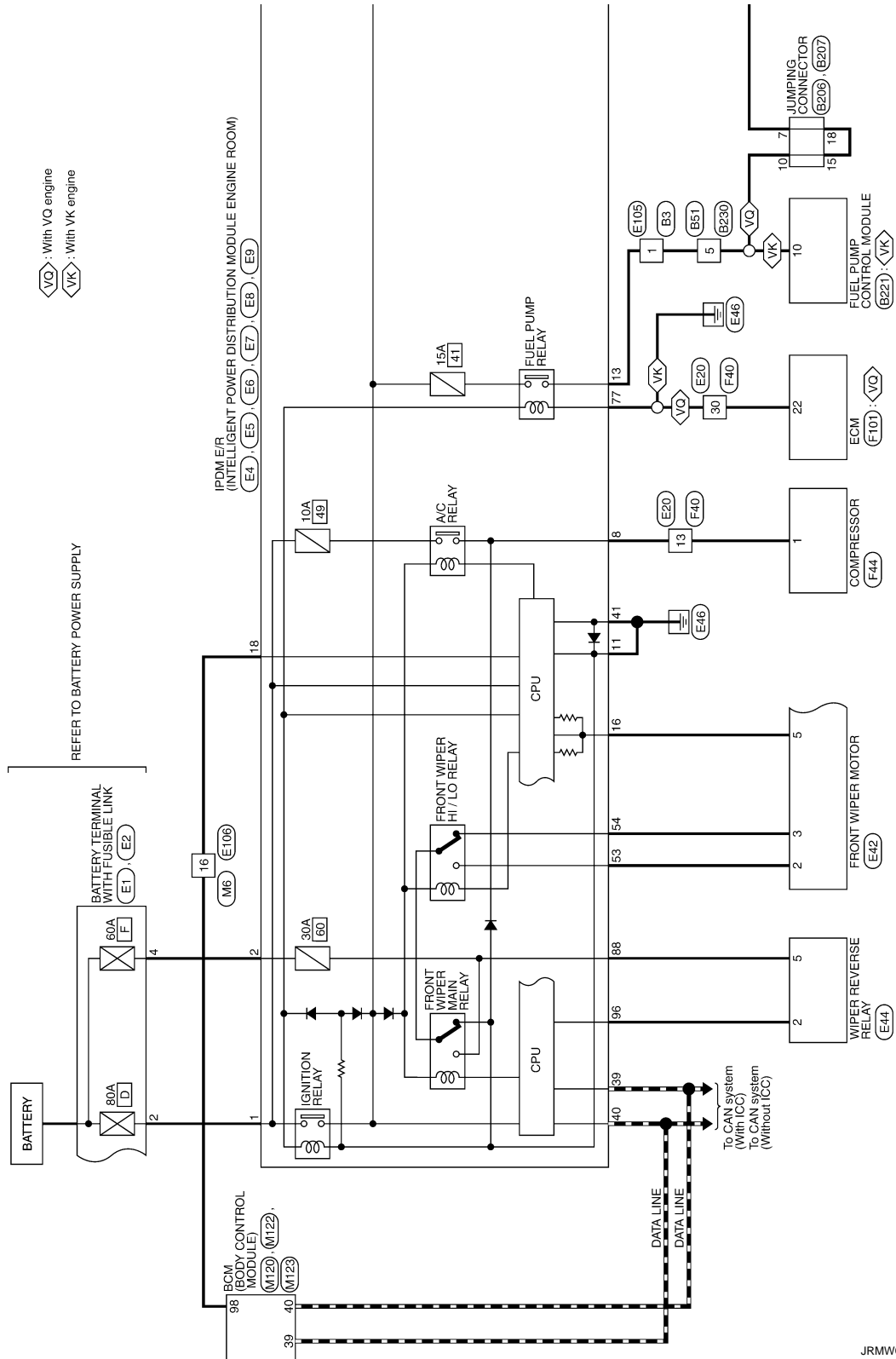

JRMWC9517GB

POWER SUPPLY ROUTING CIRCUIT

< WIRING DIAGRAM >

◊VO◊ : With VQ engine
 ◊VK◊ : With VK engine
 *1 4: ◊VO◊
 5: ◊VK◊
 *2 4: ◊VO◊
 5: ◊VK◊

*: This connector is not shown in "Harness Layout".

IPDM E/R
(INTELLIGENT POWER DISTRIBUTION MODULE ENGINE ROOM)

(E4) (E5) (E6) (E7) (E8) (E9)

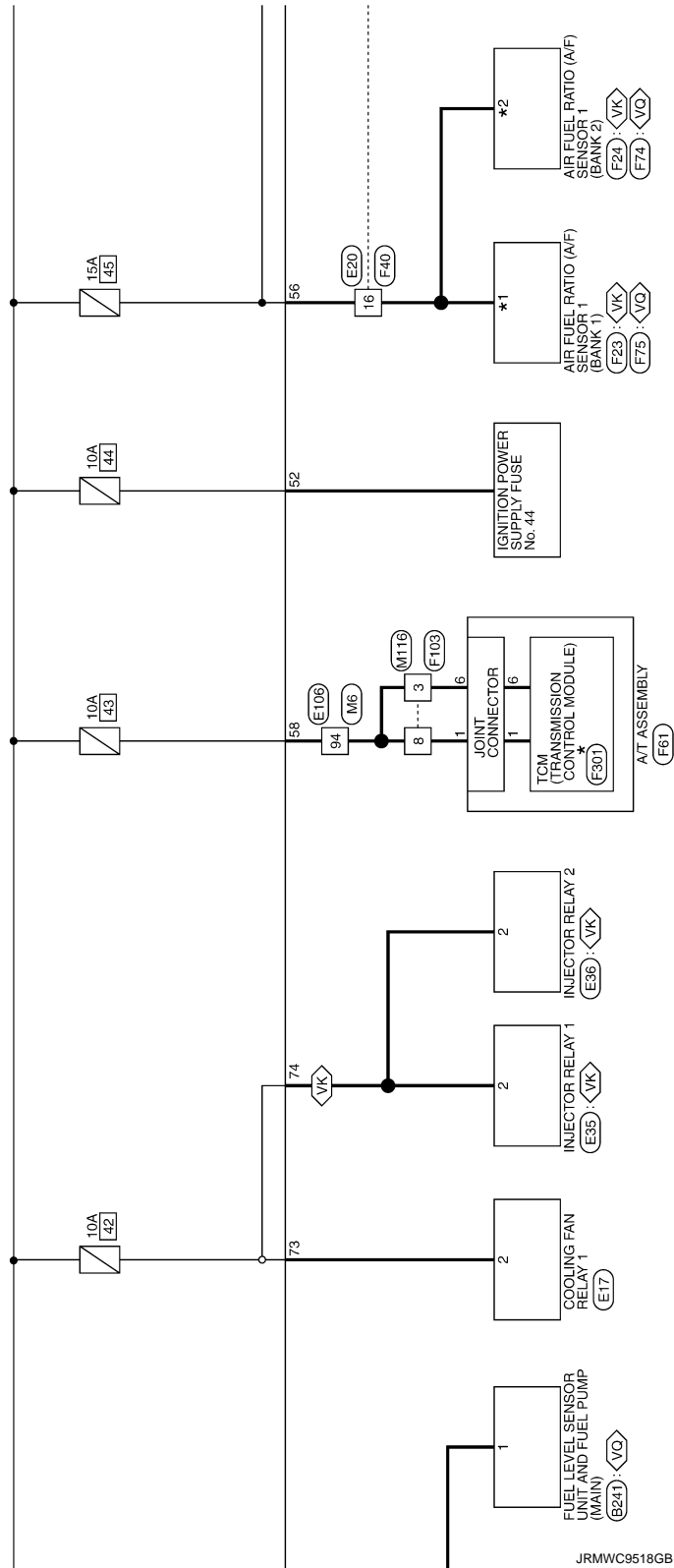

JRMWC9518GB

A
B
C
D
E
F
G
H
I
J
K
L
PG
N
O
P

POWER SUPPLY ROUTING CIRCUIT

< WIRING DIAGRAM >

◁VQ▷ : With VQ engine
 ◁VK▷ : With VK engine

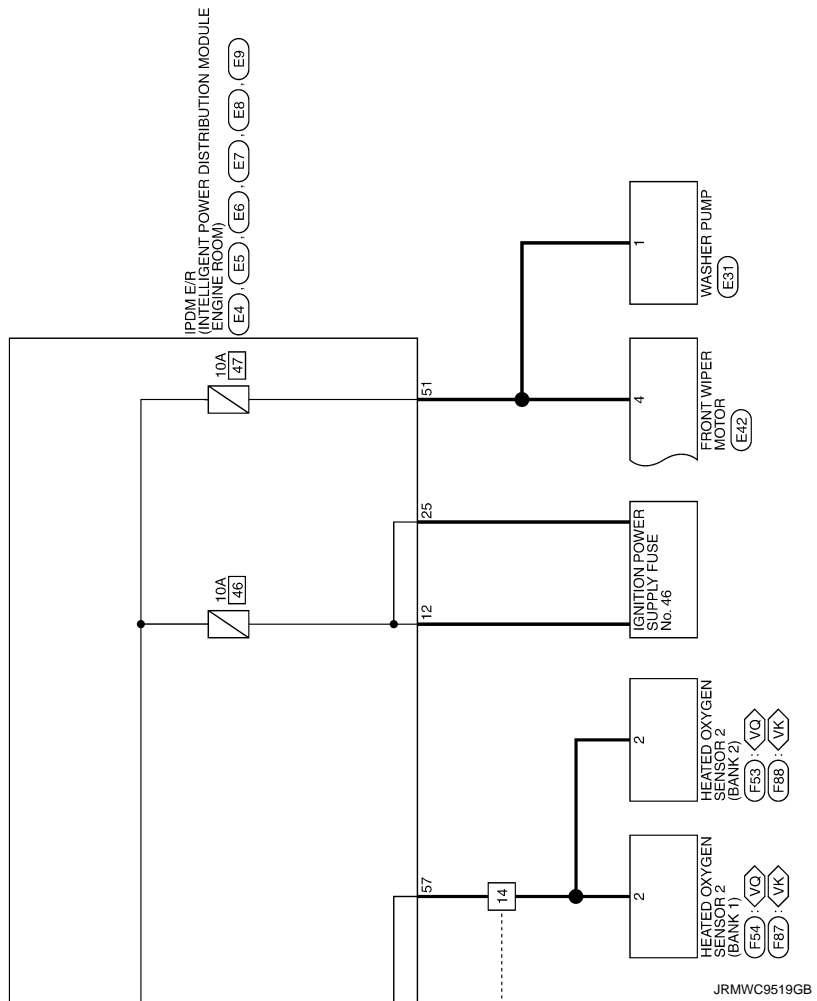

POWER SUPPLY ROUTING CIRCUIT

< WIRING DIAGRAM >

Wiring Diagram - IGNITION POWER SUPPLY FUSE No. 3 -

INFOID:000000008131327

For connector terminal arrangements, harness layouts, and alphabets in a  (option abbreviation; if not described in wiring diagram), refer to [GI-12, "Connector Information"](#).

IGNITION POWER SUPPLY FUSE No. 3

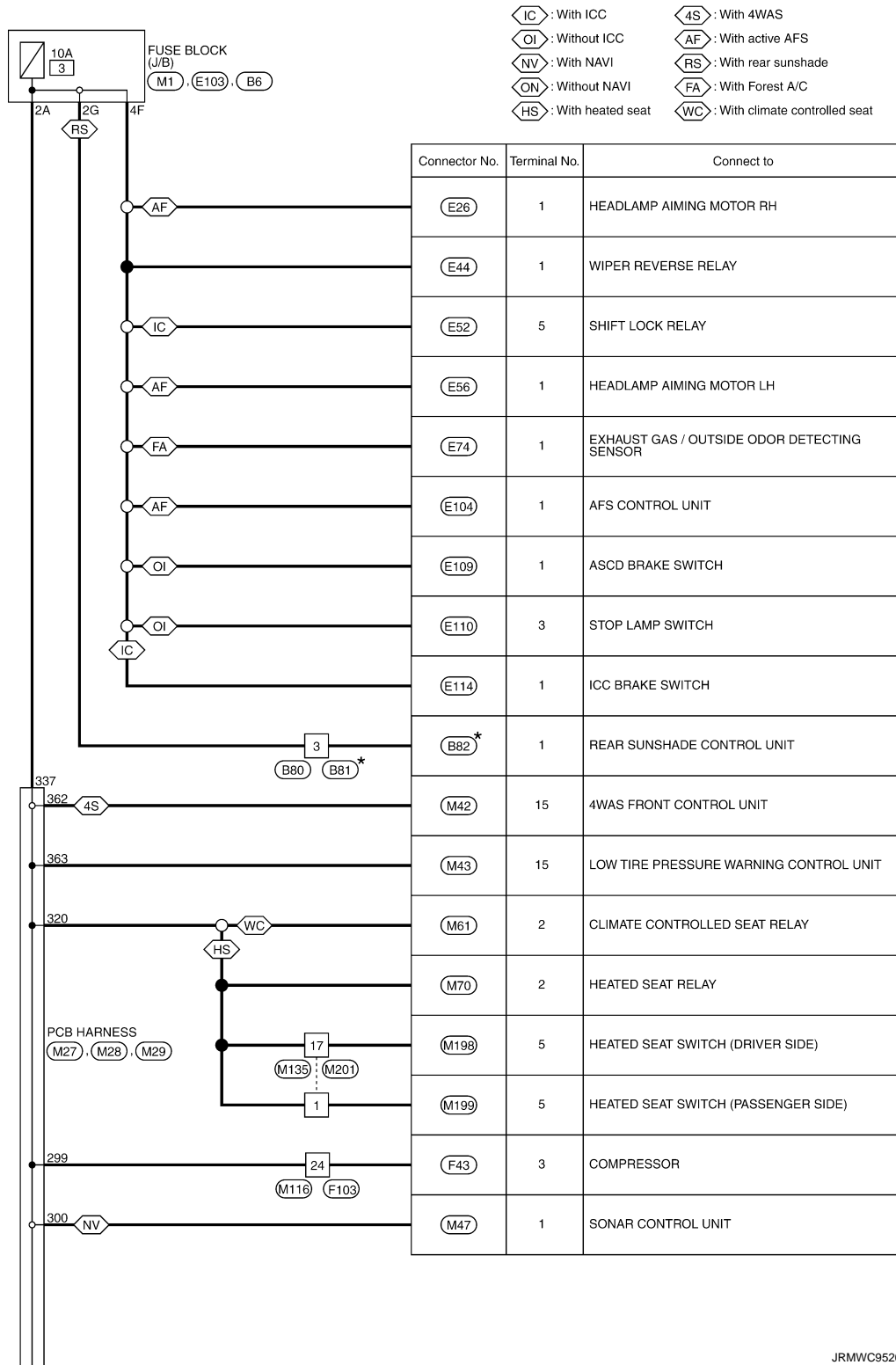

JRMWC9520GB

A
B
C
D
E
F
G
H
I
J
K
L
PG
N
O
P

POWER SUPPLY ROUTING CIRCUIT

< WIRING DIAGRAM >

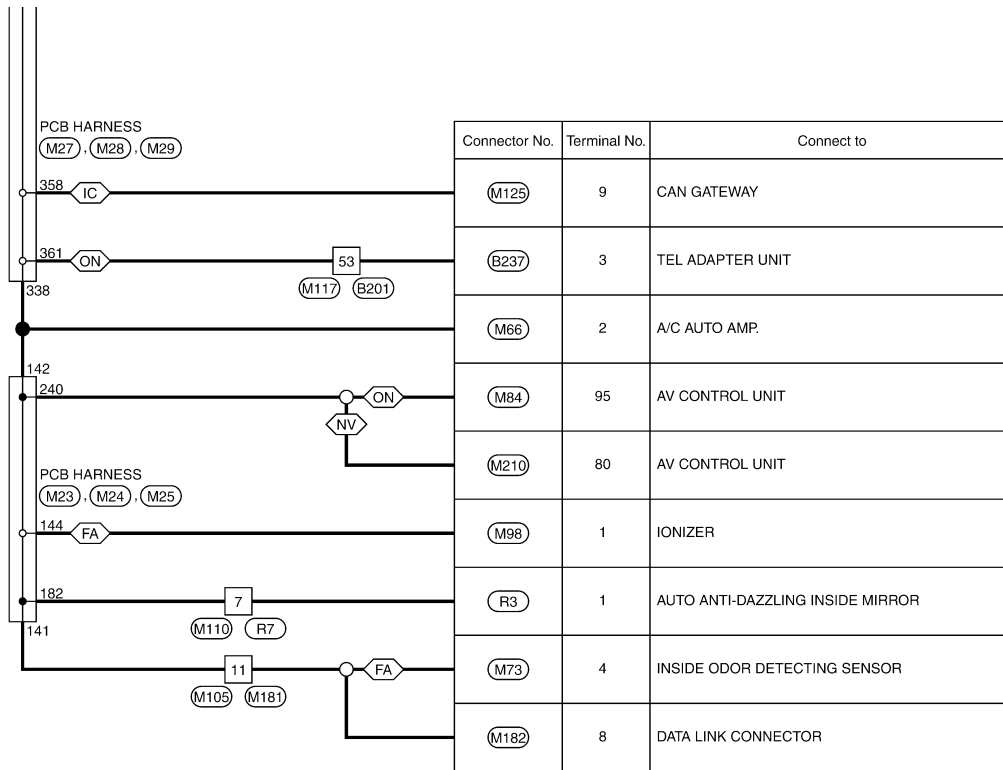

*: This connector is not shown in "Harness Layout".

2012/02/27

JRMWC9521GB

POWER SUPPLY ROUTING CIRCUIT

< WIRING DIAGRAM >

Wiring Diagram - IGNITION POWER SUPPLY FUSE No. 4 -

INFOID:000000008131328

For connector terminal arrangements, harness layouts, and alphabets in a  (option abbreviation; if not described in wiring diagram), refer to [GI-12, "Connector Information"](#).

IGNITION POWER SUPPLY FUSE No. 4

 With active AFS

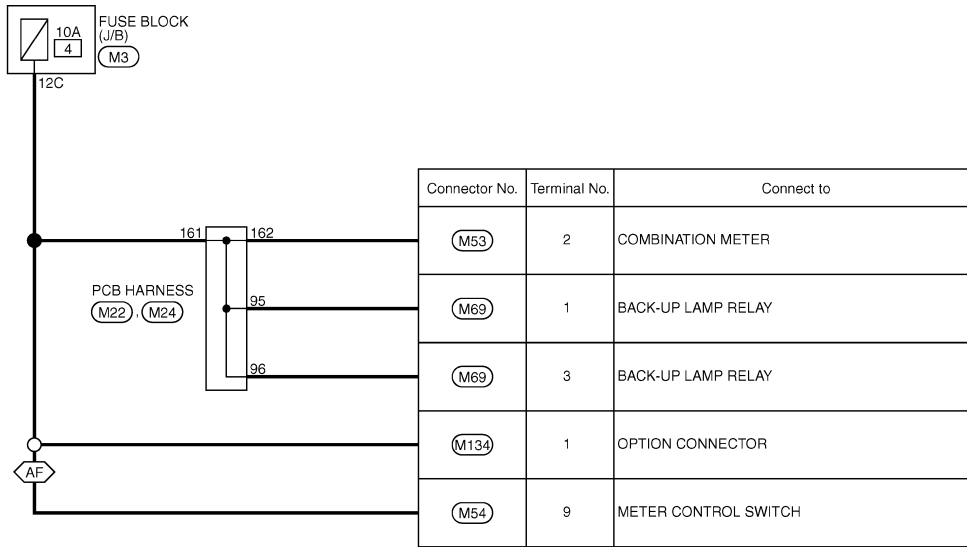

2010/02/03

JCMWA5688GB

PG

N

O

P

POWER SUPPLY ROUTING CIRCUIT

< WIRING DIAGRAM >

Wiring Diagram - IGNITION POWER SUPPLY FUSE No. 44 -

INFOID:000000008131329

For connector terminal arrangements, harness layouts, and alphabets in a  (option abbreviation; if not described in wiring diagram), refer to [GI-12, "Connector Information"](#).

IGNITION POWER SUPPLY FUSE No. 44

 : With VQ engine

 : With VK engine

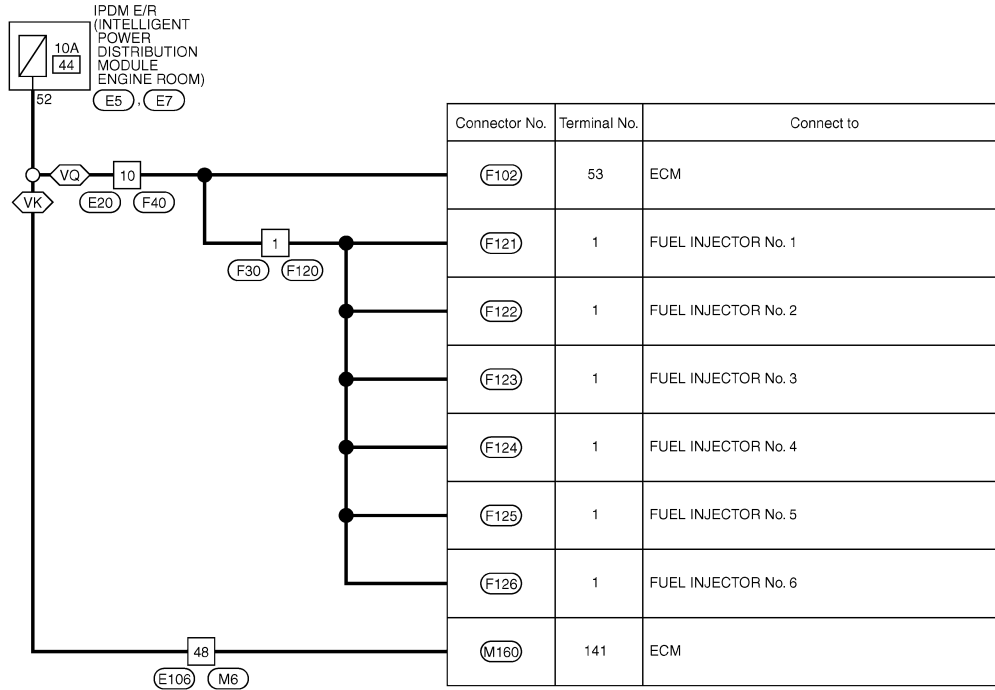

2010/02/03

JCMWA5691GB

POWER SUPPLY ROUTING CIRCUIT



< WIRING DIAGRAM >

Wiring Diagram - IGNITION POWER SUPPLY FUSE No. 46 -

INFOID:000000008131330

For connector terminal arrangements, harness layouts, and alphabets in a  (option abbreviation; if not described in wiring diagram), refer to [GI-12, "Connector Information"](#).

IGNITION POWER SUPPLY FUSE No. 46

-  : AWD models
-  : With ICC
-  : With 4WAS

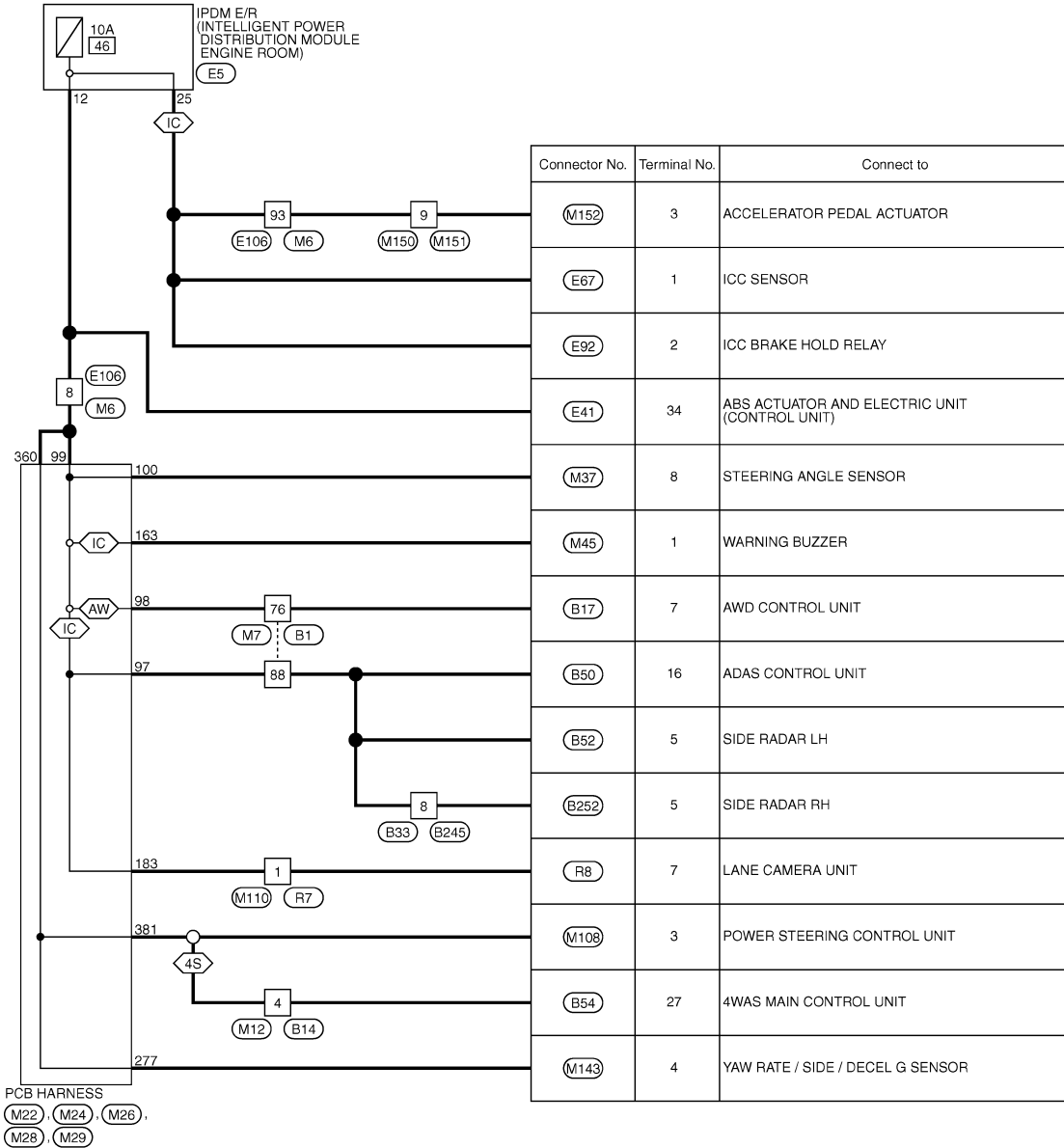

2010/02/03

JCMWA5696GB

A
B
C
D
E
F
G
H
I
J
K
L
N
O
P

PG

OPTION HARNESS

< WIRING DIAGRAM >

OPTION HARNESS

Wiring Diagram

INFOID:000000008131331

For connector terminal arrangements, harness layouts, and alphabets in a  (option abbreviation; if not described in wiring diagram), refer to [GI-12, "Connector Information"](#).

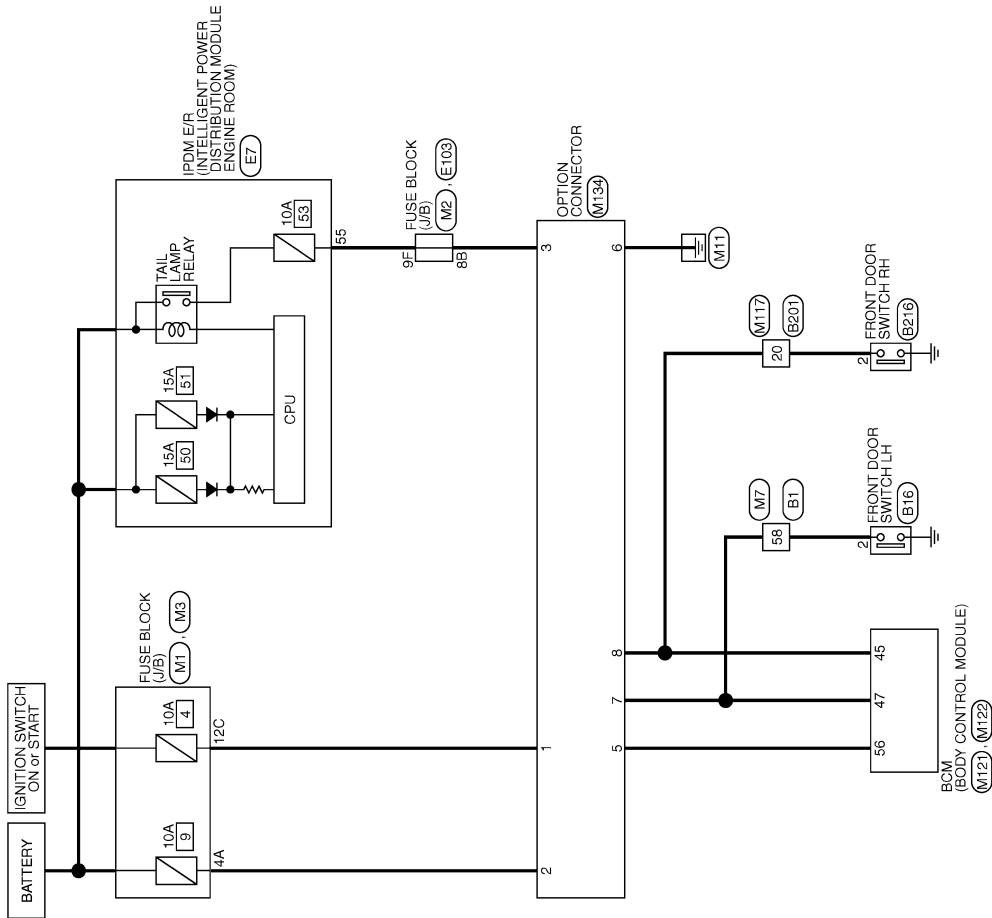

OPTION HARNESS

2010/12/14

JCMWA7335GB

FUSE BLOCK - JUNCTION BOX (J/B)

< WIRING DIAGRAM >

FUSE BLOCK - JUNCTION BOX (J/B)

Fuse, Connector and Terminal Arrangement

INFOID:000000008131332

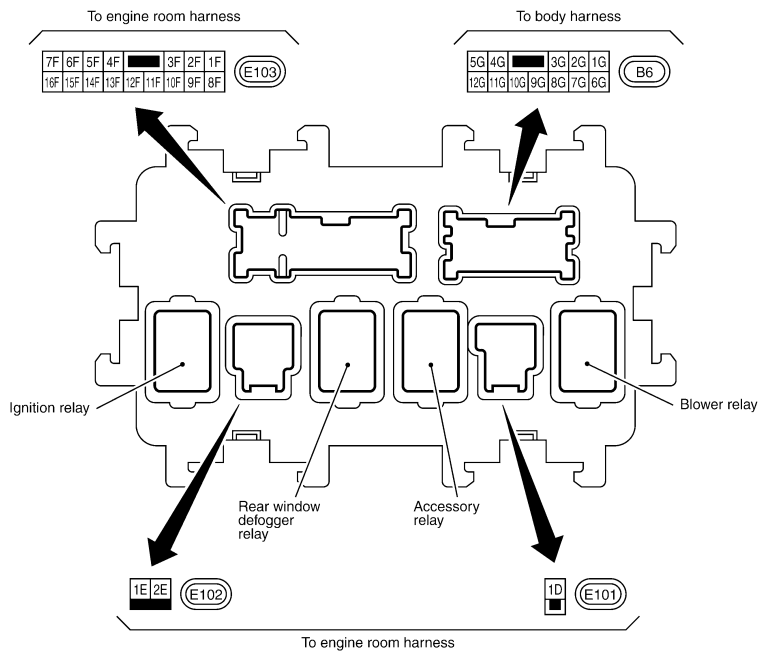
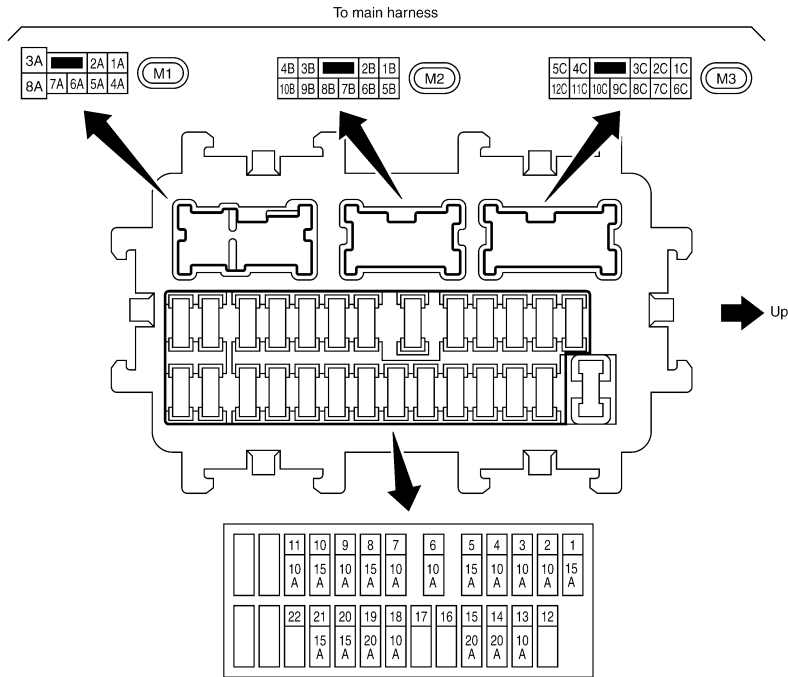

2012/02/27

JRMWC9522GB

FUSE, FUSIBLE LINK AND RELAY BOX

< WIRING DIAGRAM >

FUSE, FUSIBLE LINK AND RELAY BOX

Fuse and Fusible Link Arrangement

INFOID:000000008131333

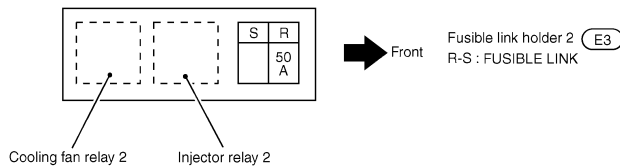
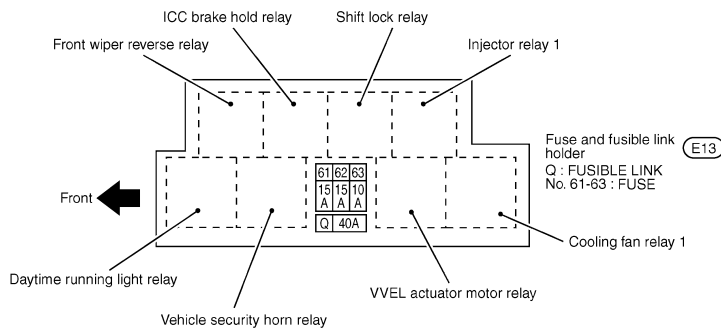
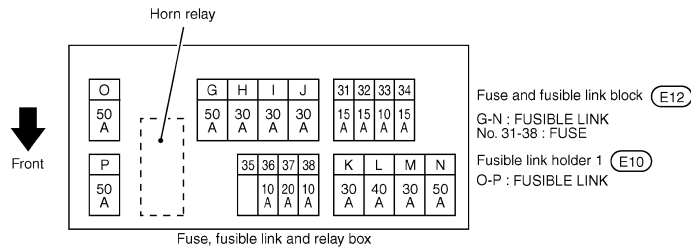
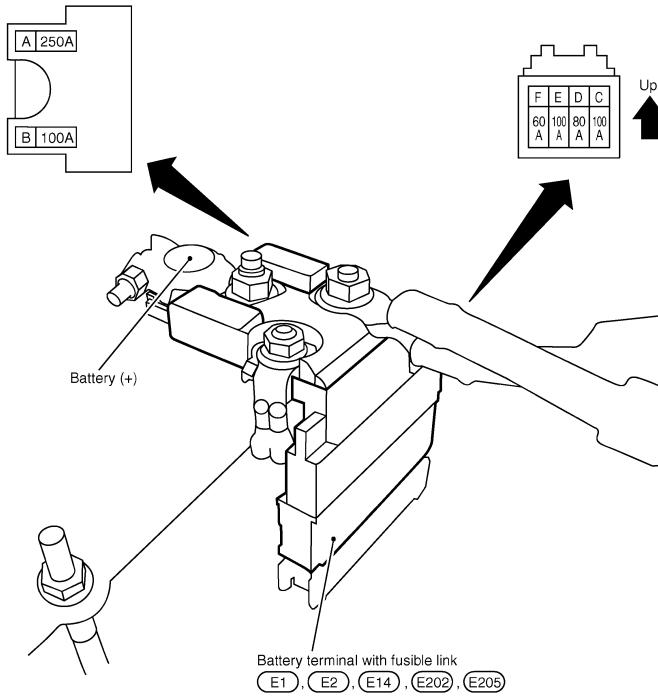

2010/12/14

JCMWA7443GB

IPDM E/R (INTELLIGENT POWER DISTRIBUTION MODULE ENGINE ROOM)

< WIRING DIAGRAM >

IPDM E/R (INTELLIGENT POWER DISTRIBUTION MODULE ENGINE ROOM)

Fuse, Connector and Terminal Arrangement

INFOID:000000008131334

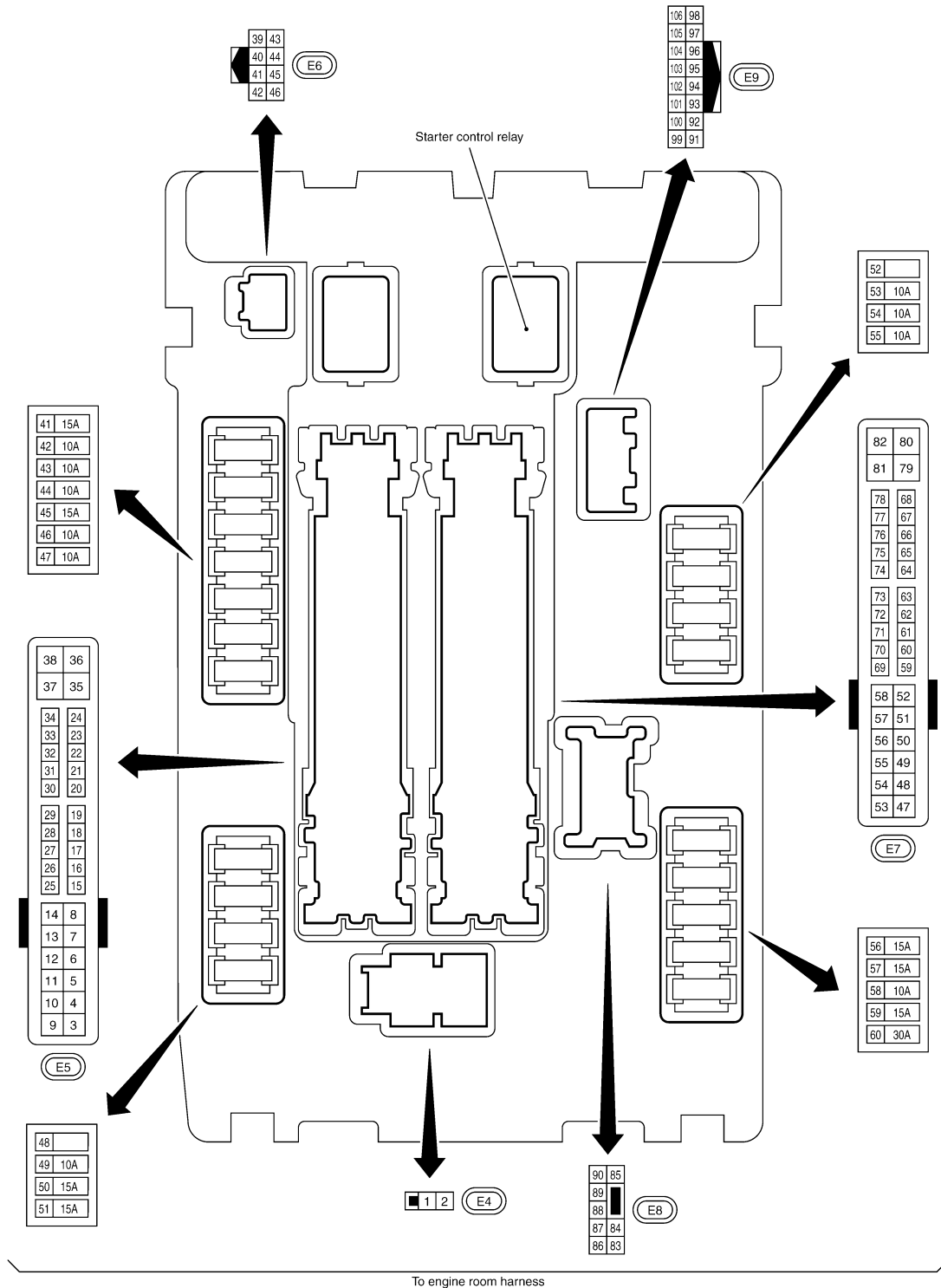

2012/02/27

JRMWC9523GB

PCB HARNESS

< WIRING DIAGRAM >

PCB HARNESS

Connector and Terminal Arrangement

INFOID:000000008131335

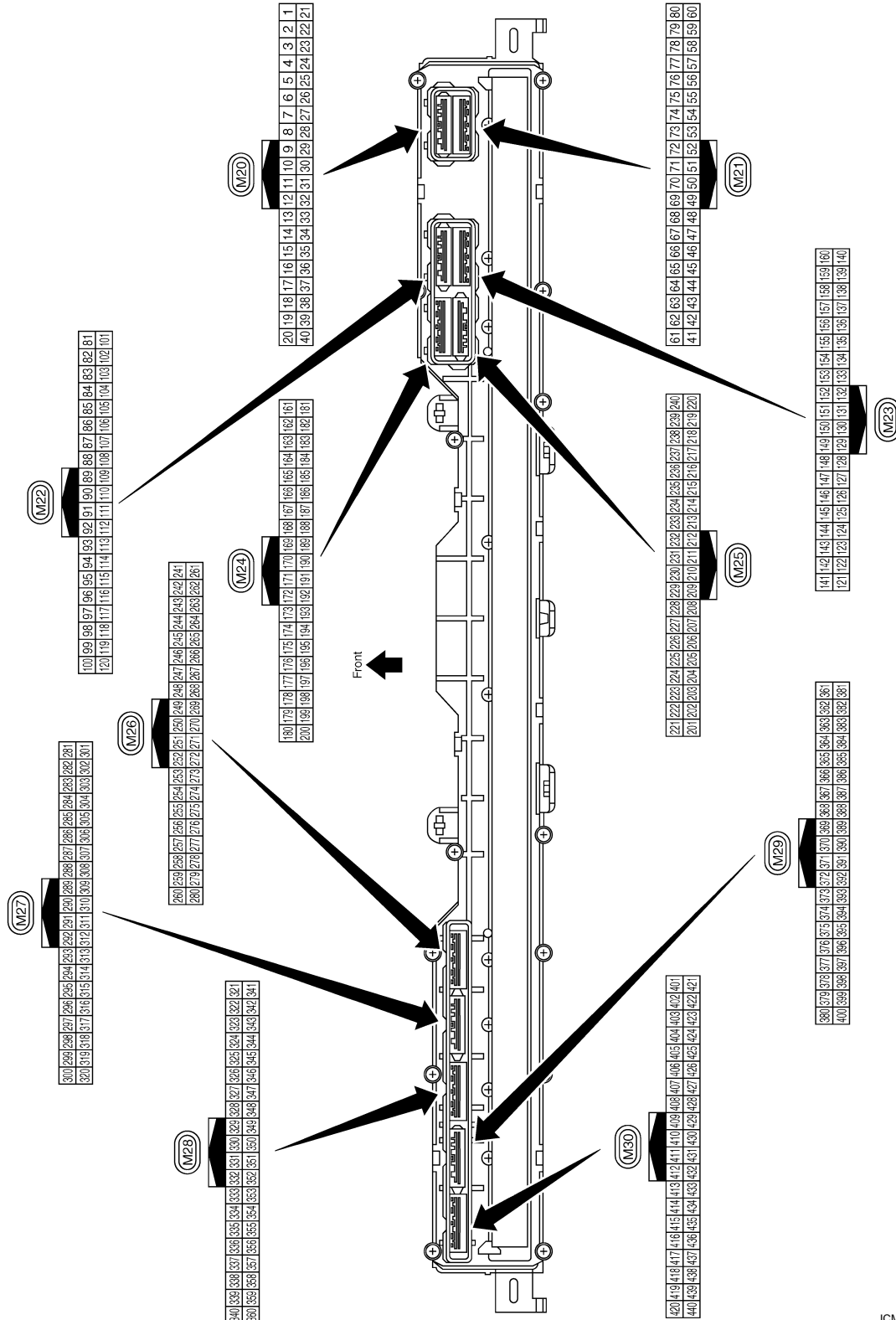

HARNESS LAYOUT

< WIRING DIAGRAM >





HARNESS LAYOUT

How To Read Harness Layout

INFOID:000000008131336

CONNECTOR SYMBOL

Main symbols of connector (in Harness Layout) are indicated in the below.

Connector type	Water proof type		Standard type	
	Male	Female	Male	Female
Connector symbol				
Ground terminal etc.	—			

JPMIA0114GB

A

B

C

D

E

F

G

H

I

J

K

L

PG

N

O

P

HARNESS LAYOUT

< WIRING DIAGRAM >

Engine Room Harness

INFOID:000000008131337

ENGINE COMPARTMENT

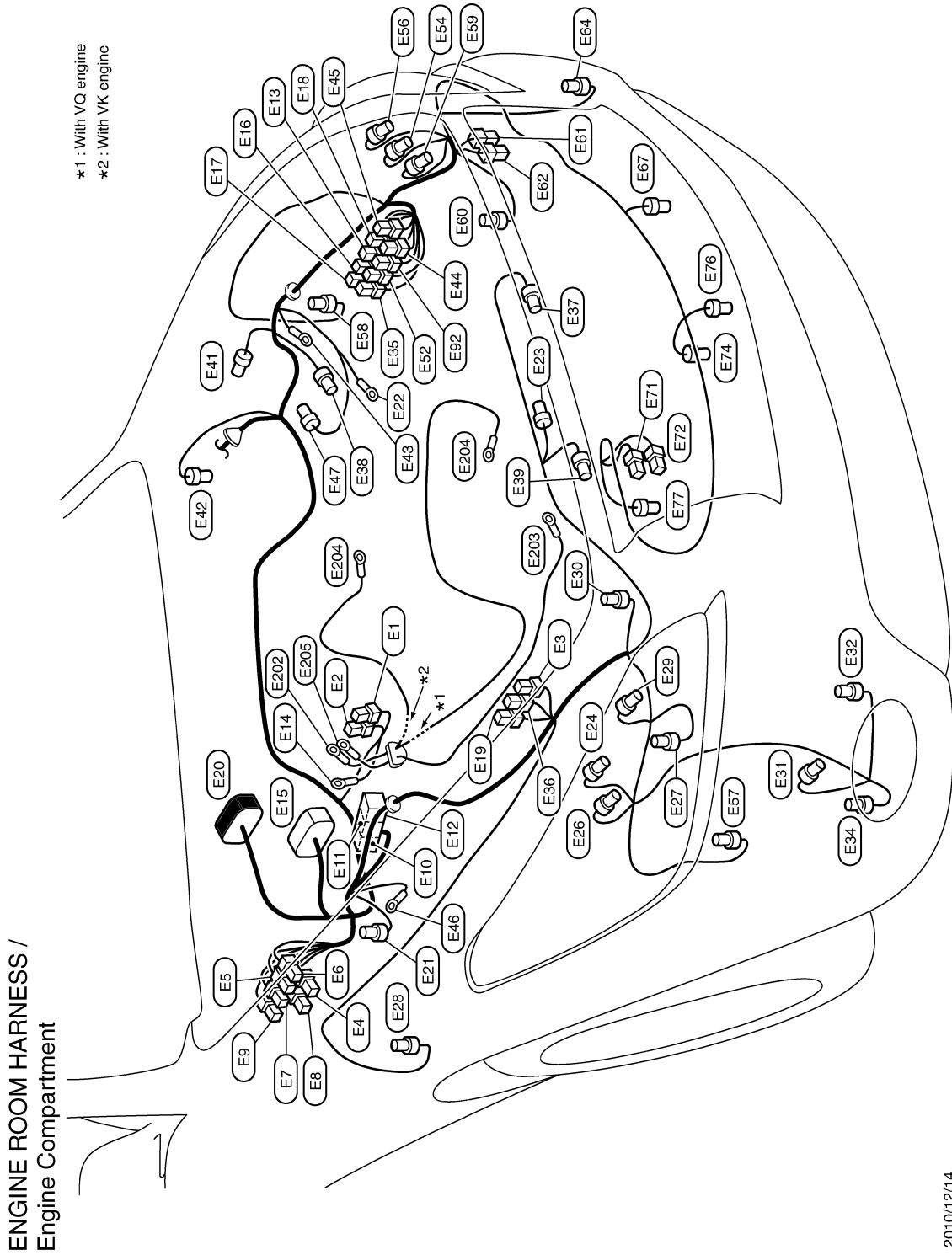

2010/12/14

JCMIA0924GB

HARNES LAYOUT

< WIRING DIAGRAM >

PASSENGER COMPARTMENT

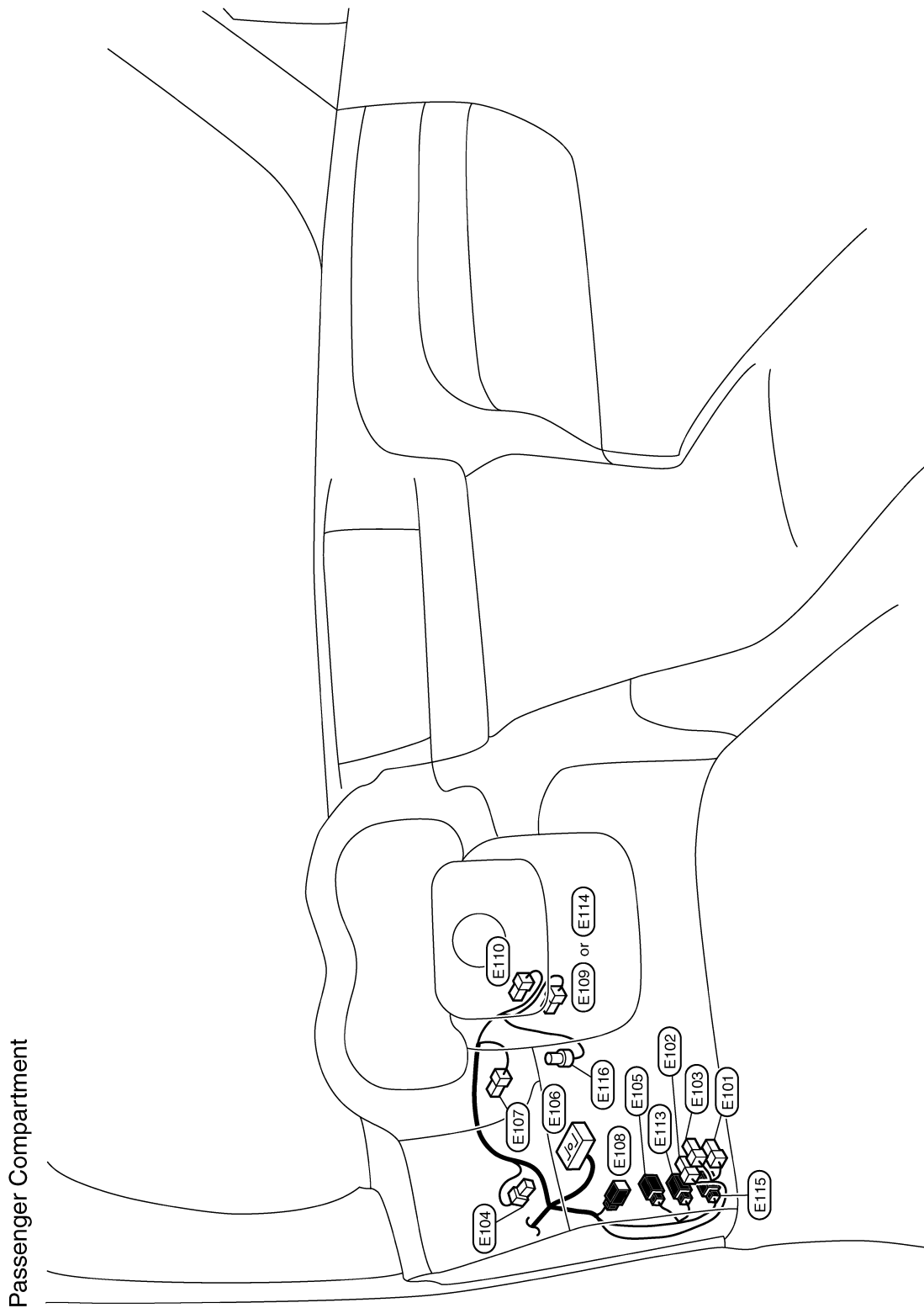

Passenger Compartment

2010/12/14

JCMIA0925GB

INFOID:000000008131338

Engine Control Harness

VQ37VHR

A
B
C
D
E
F
G
H
I
J
K
L
N
O
P

PG

HARNES LAYOUT

< WIRING DIAGRAM >

Engine Compartment

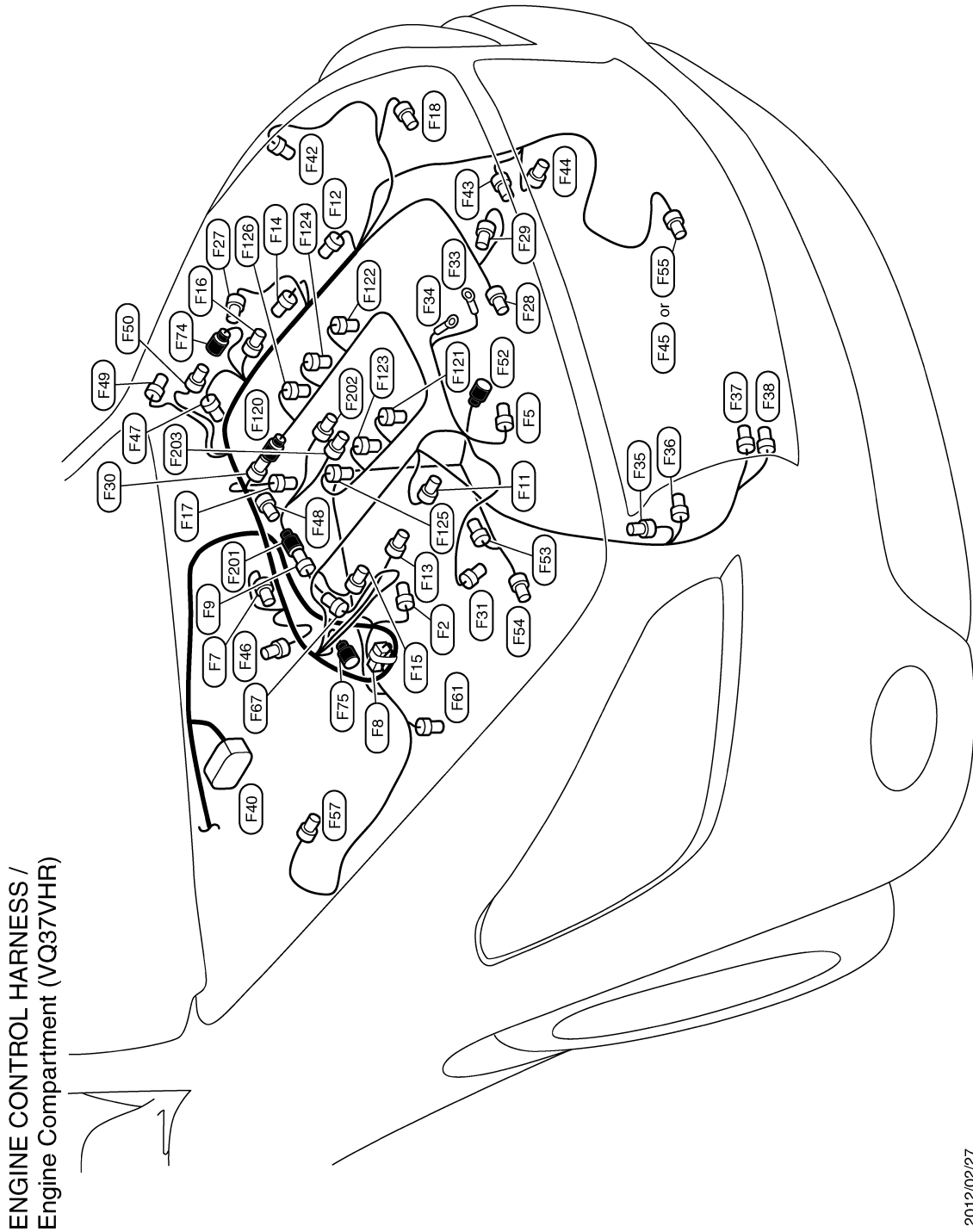

ENGINE CONTROL HARNESS /
Engine Compartment (VQ37VHR)

2012/02/27

JRMIC1408GB

HARNES LAYOUT

< WIRING DIAGRAM >

Passenger Compartment

Passenger Compartment (VQ37VHR)

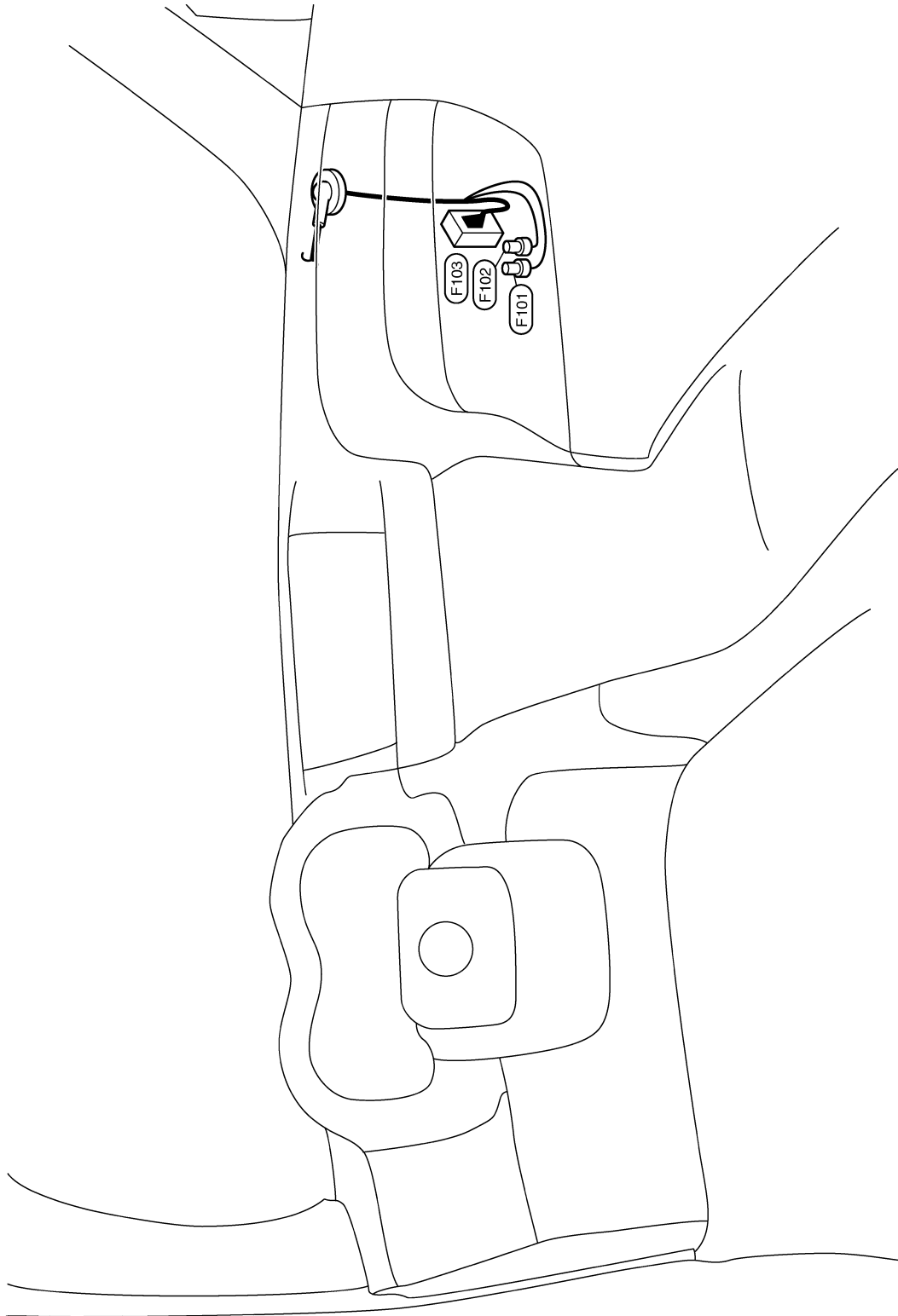

2010/02/03

JCMIA0752GB

VK56VD

A
B
C
D
E
F
G
H
I
J
K
L
PG
N
O
P

HARNES LAYOUT

< WIRING DIAGRAM >

Engine Compartment

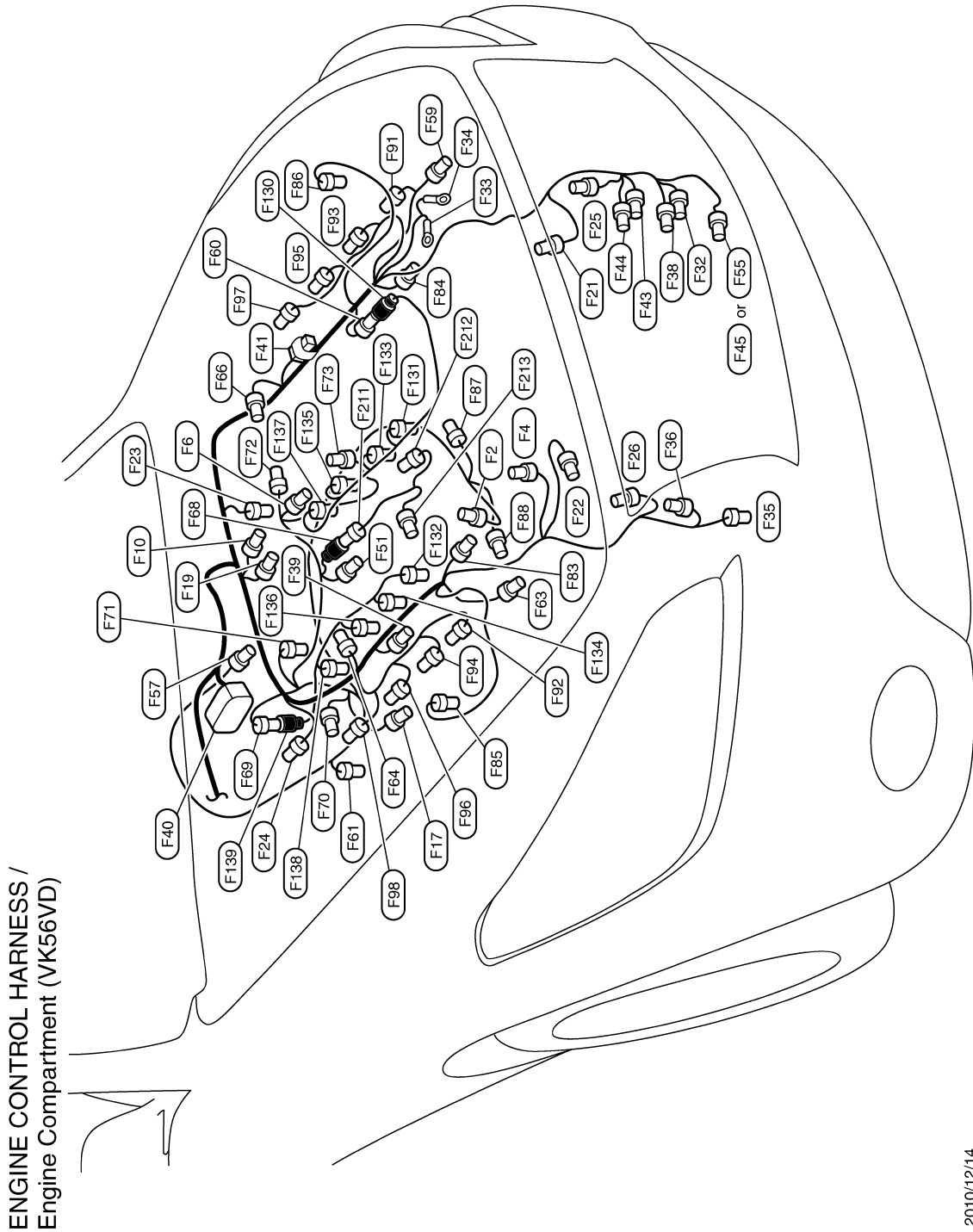

HARNES LAYOUT

< WIRING DIAGRAM >

Passenger Compartment

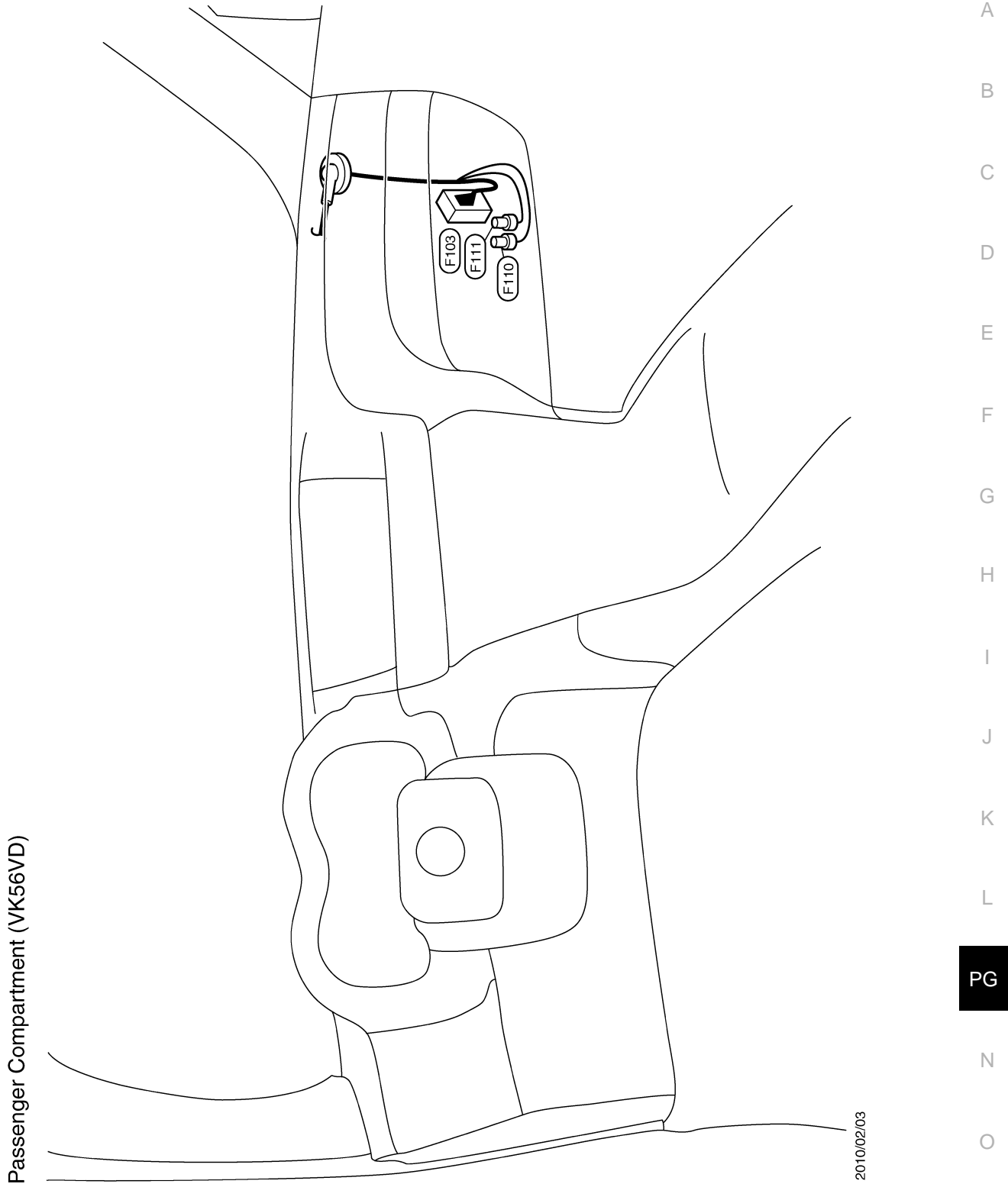

Passenger Compartment (VK56VD)

2010/02/03

JCMIA0754GB

A
B
C
D
E
F
G
H
I
J
K
L
PG
N
O
P

HARNESS LAYOUT

< WIRING DIAGRAM >

Main Harness

INFOID:000000008131339

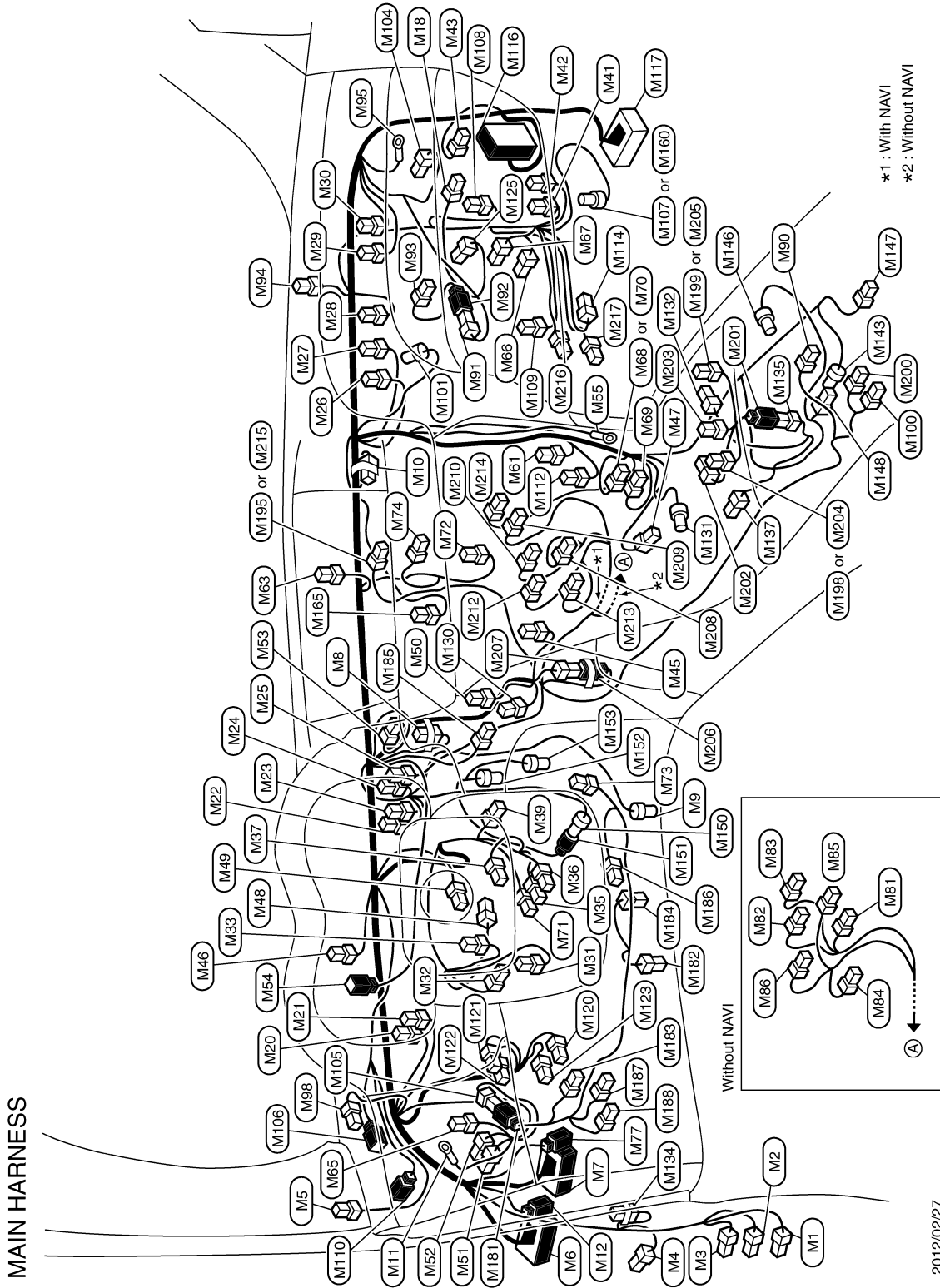

2012/02/27

JRMIC1409GB

HARNES LAYOUT

< WIRING DIAGRAM >

Body Harness

INFOID:000000008131340

BODY HARNESS

BODY HARNESS

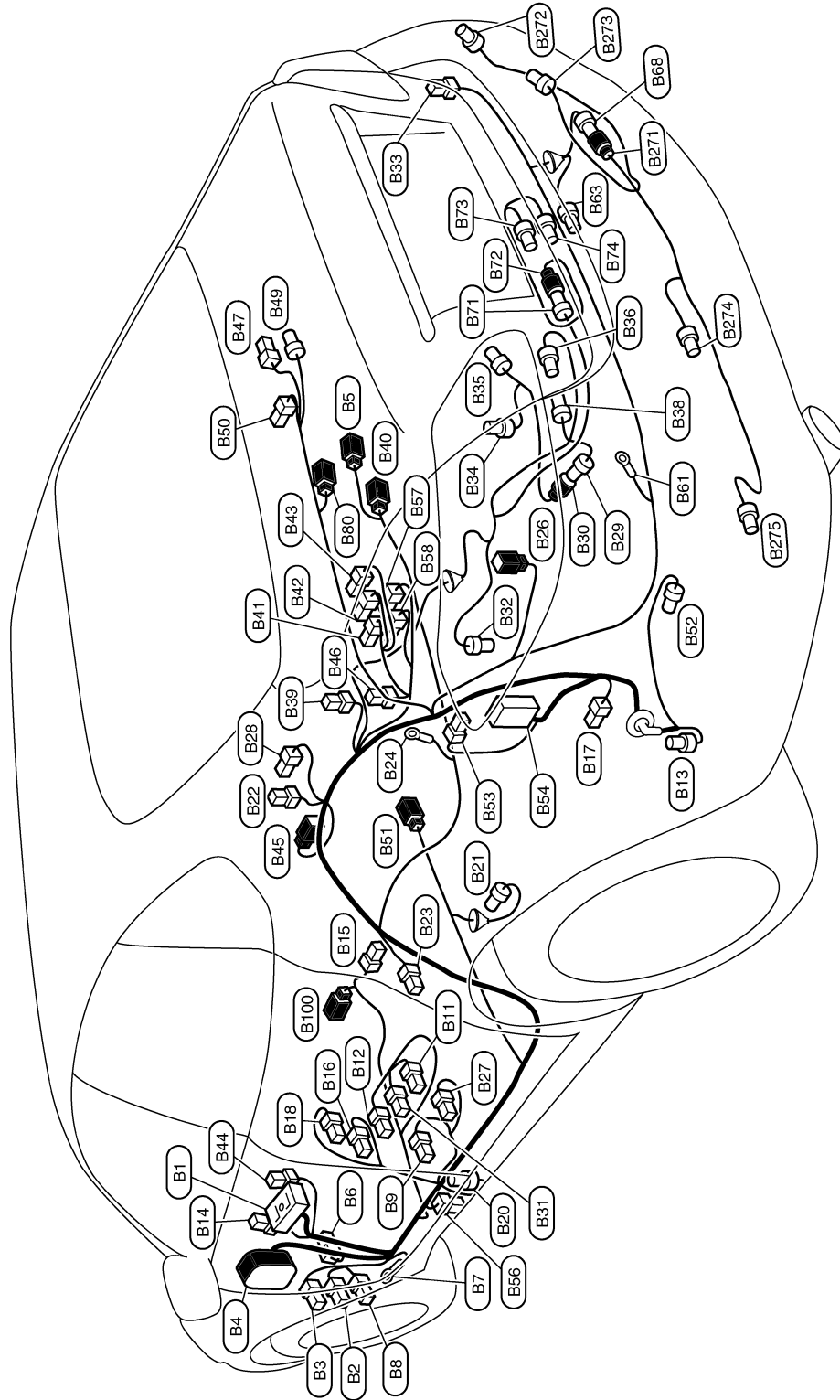

2012/02/27

JRMIC1410GB

A
B
C
D
E
F
G
H
I
J
K
L
PG
N
O
P

HARNESS LAYOUT

< WIRING DIAGRAM >
BODY No. 2 HARNESS

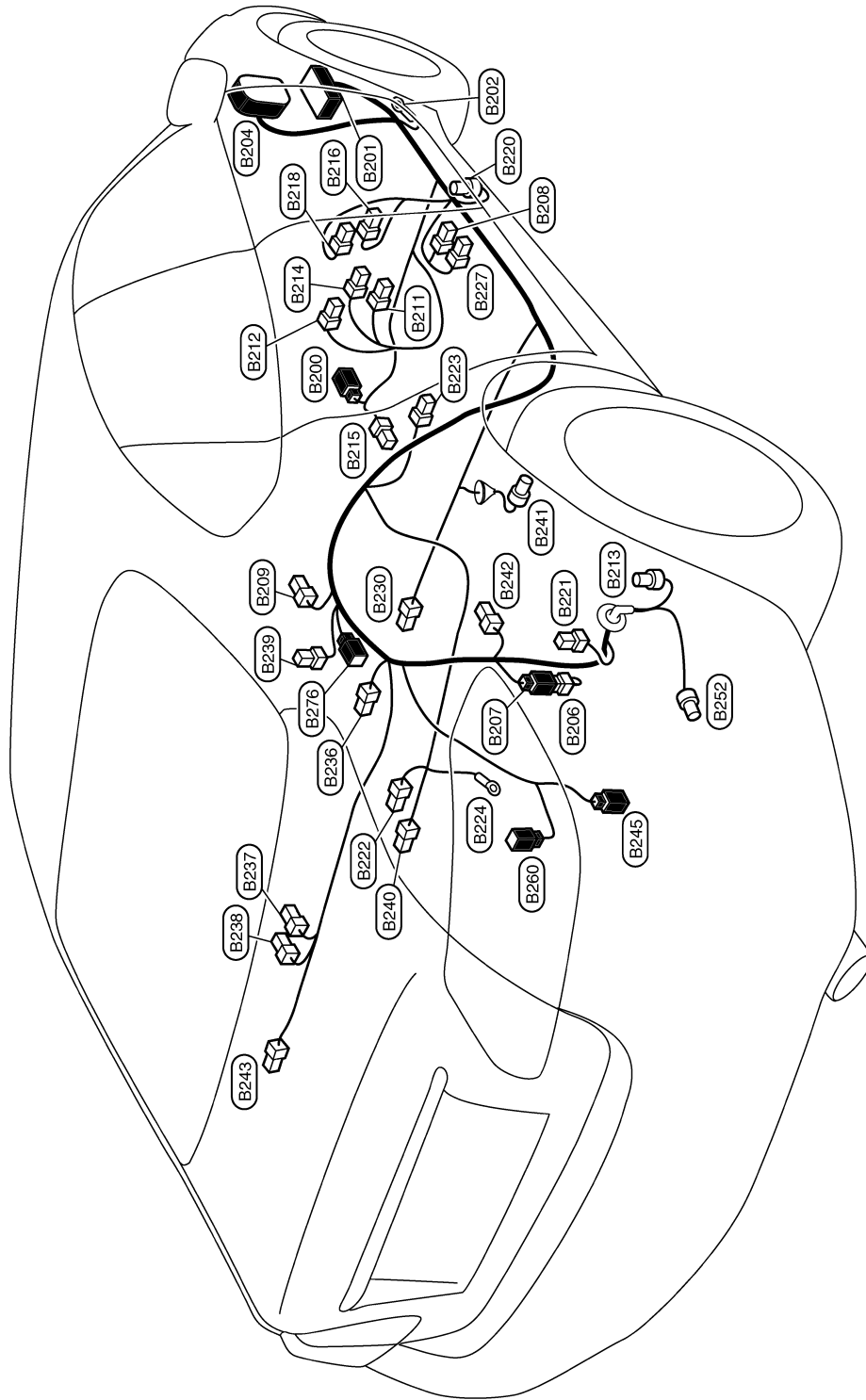

BODY No. 2 HARNESS

2012/02/27

JRMIC1411GB

HARNES LAYOUT

< WIRING DIAGRAM >

Door Harness

INFOID:000000008131341

FRONT DOOR HARNESS (LH SIDE)

FRONT DOOR HARNESS (LH SIDE)

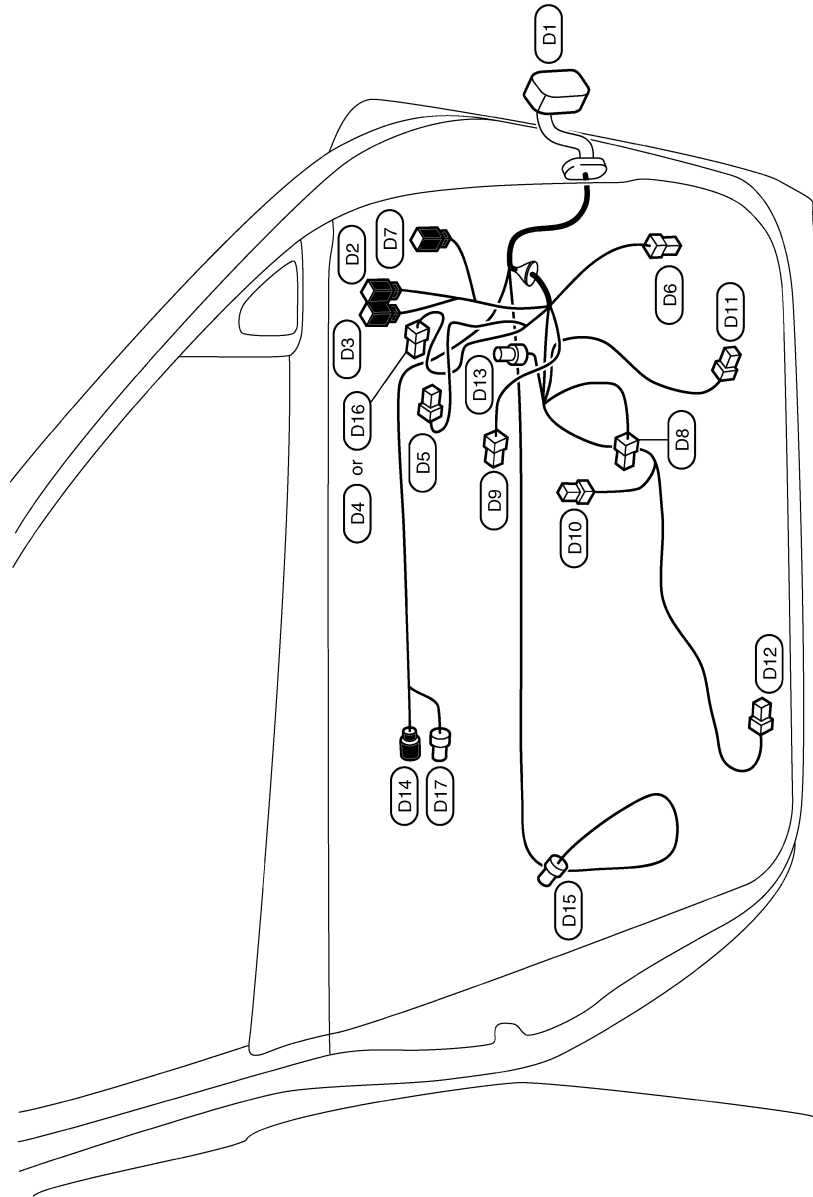

A
B
C
D
E
F
G
H
I
J
K
L
N
O
P

PG

2010/02/03

JCMIA0758GB

HARNES LAYOUT

< WIRING DIAGRAM >

FRONT DOOR HARNESS (RH SIDE)

FRONT DOOR HARNESS (RH SIDE)

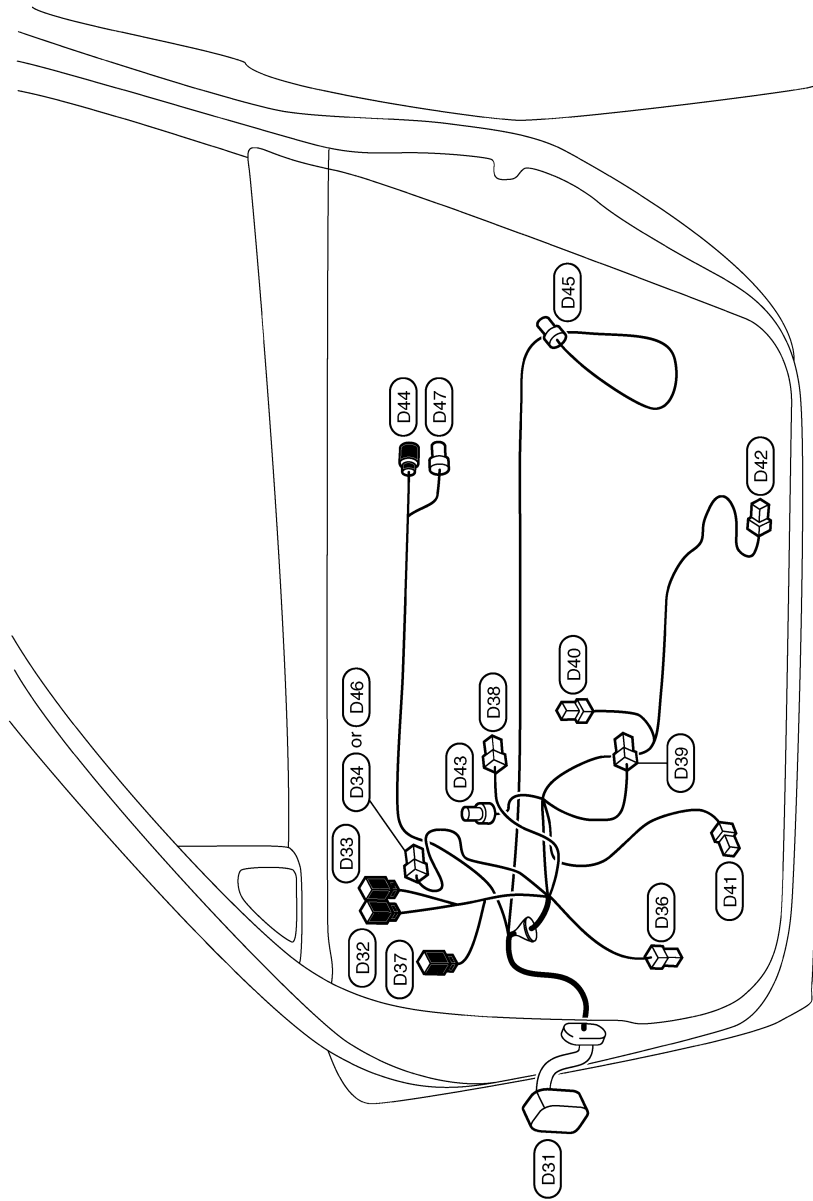

2010/02/03

JCMIA0759GB

HARNESS LAYOUT

< WIRING DIAGRAM >

REAR DOOR HARNESS (LH SIDE)

REAR DOOR HARNESS (LH SIDE)

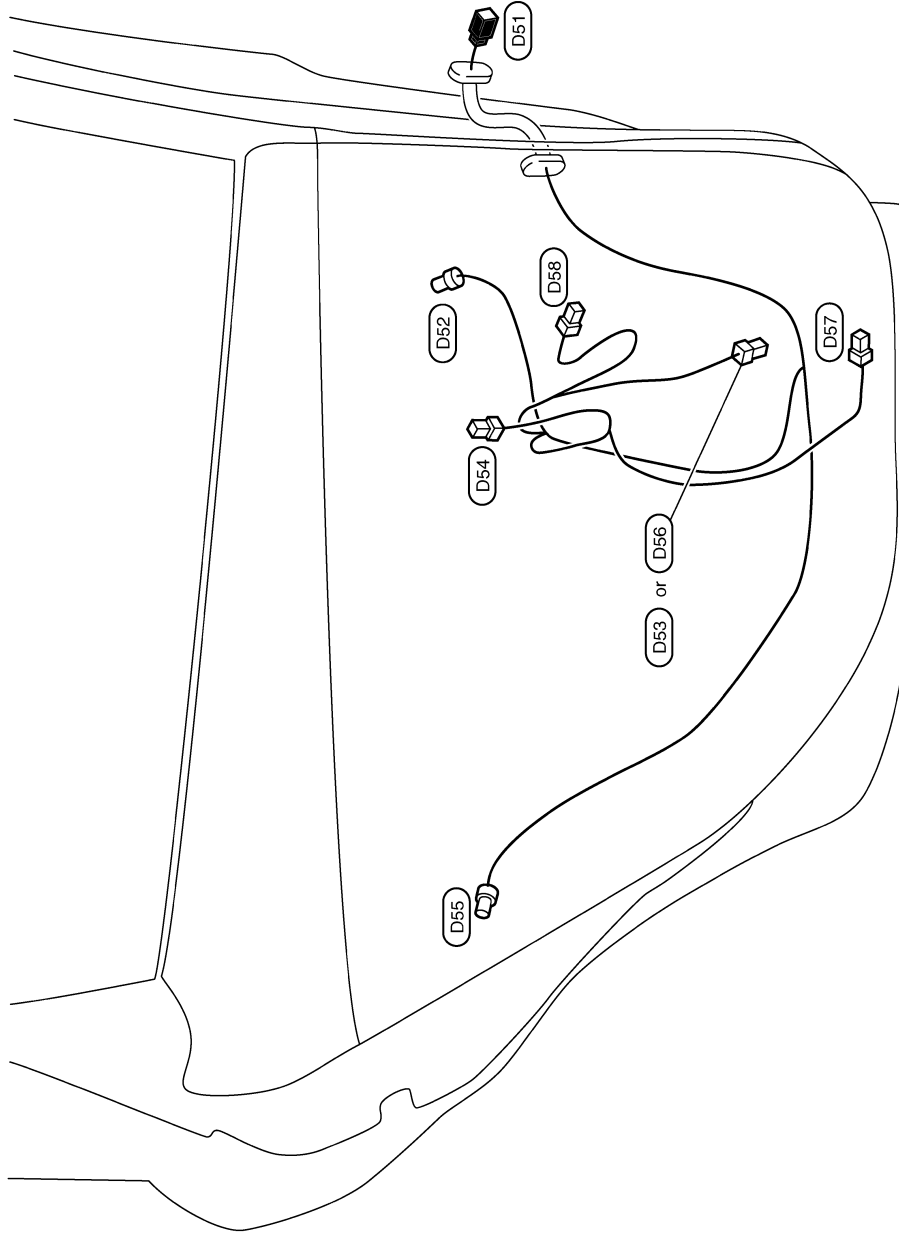

2010/02/03

JCMIA0760GB

A
B
C
D
E
F
G
H
I
J
K
L
PG
N
O
P

HARNES LAYOUT

< WIRING DIAGRAM >

REAR DOOR HARNESS (RH SIDE)

REAR DOOR HARNESS (RH SIDE)

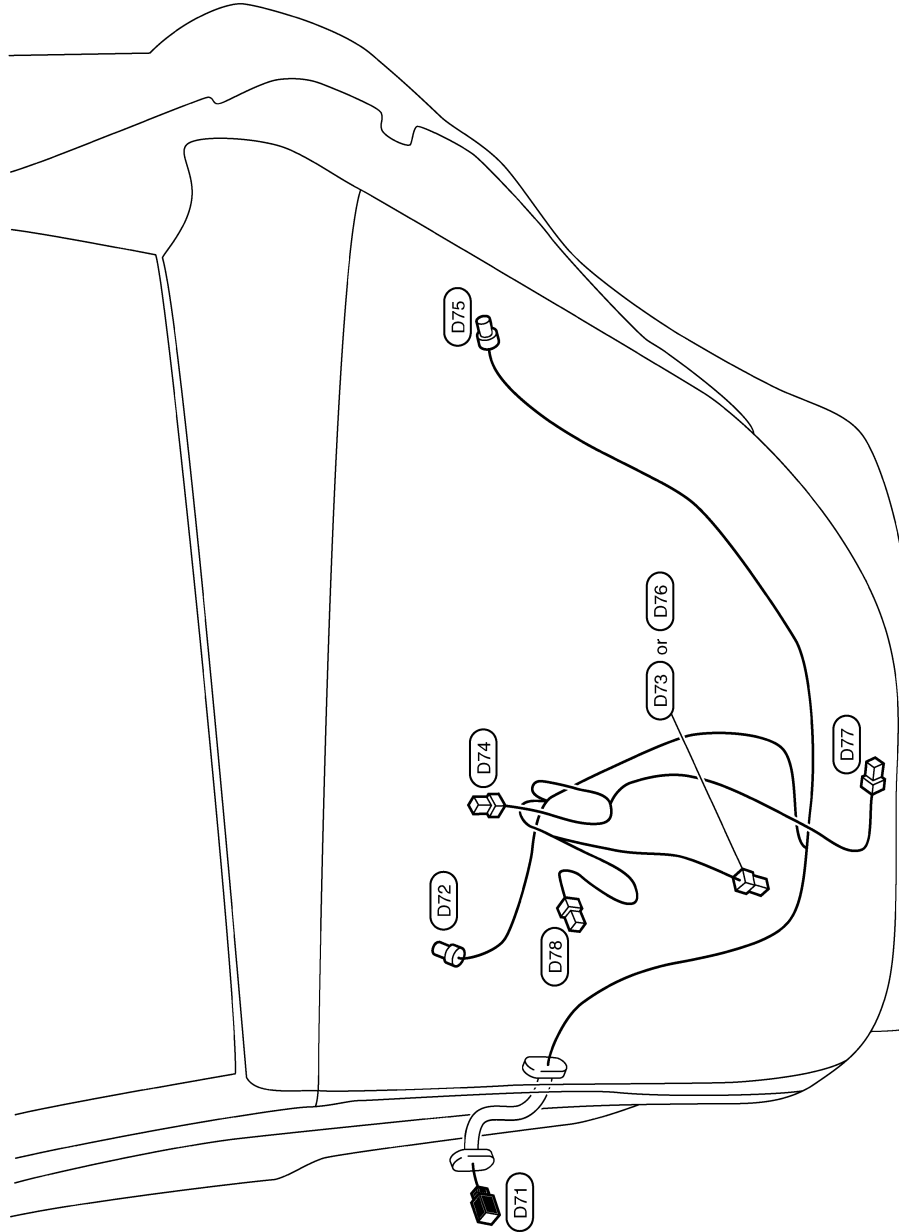

2010/02/03

JCMIA0761GB

HARNES LAYOUT

< WIRING DIAGRAM >

Room Lamp Harness

INFOID:000000008131342

ROOM LAMP HARNESS



A
B
C
D
E
F
G
H
I
J
K
L
PG
N
O
P

2012/02/27

JRMIC1412GB

HARNESS LAYOUT

< WIRING DIAGRAM >

Tail Harness

INFOID:000000008131343

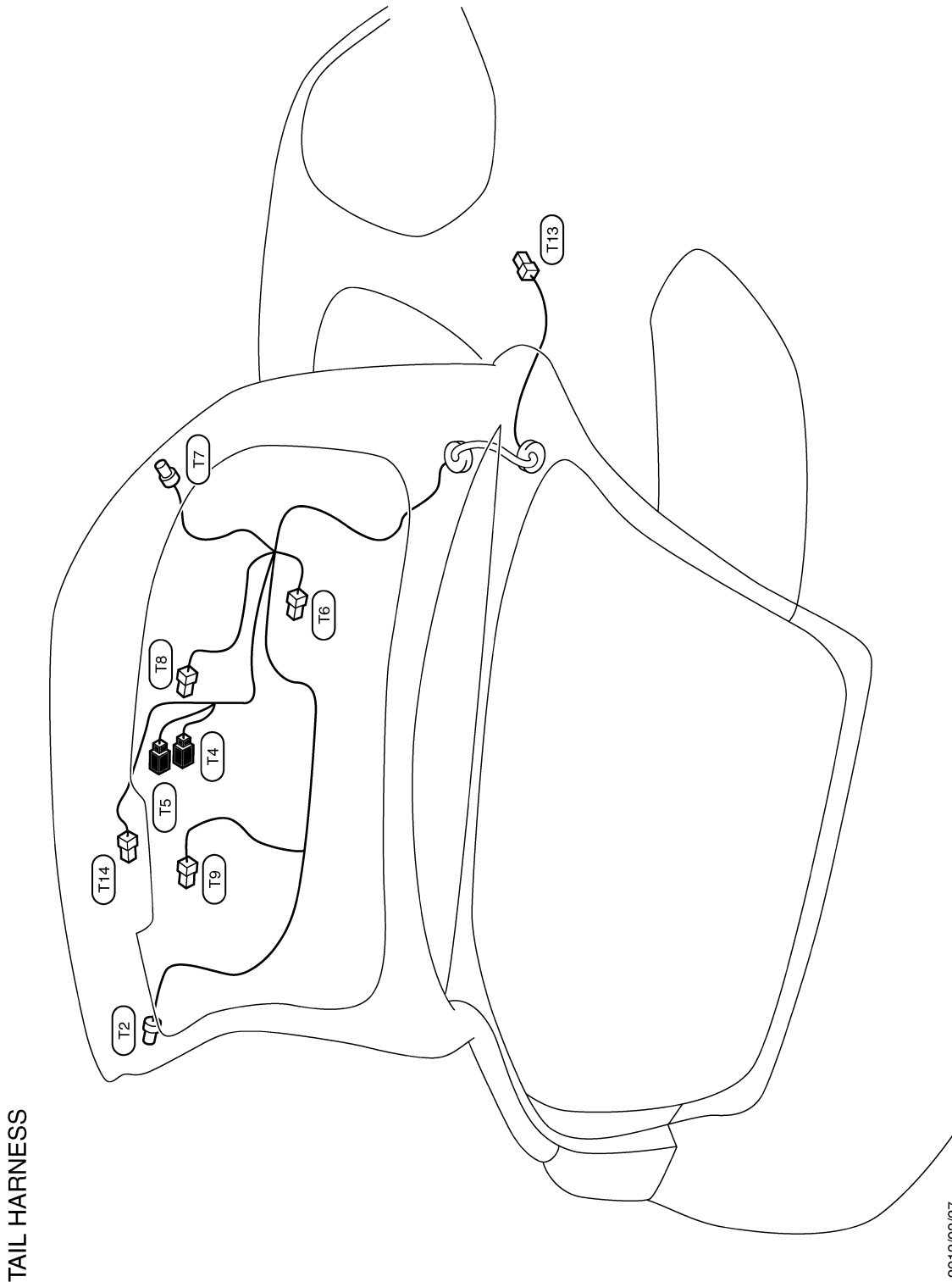

TAIL HARNESS

2012/02/27

JRMIC1413GB

CONNECTOR INFORMATION

< WIRING DIAGRAM >

CONNECTOR INFORMATION

How to Read Connector Type

INFOID:000000008131344

- 1 : Connector model
- 2 : Cavity
- 3 : Male (M) and female (F) terminals
- 4 : Connector color
- 5 : Special type

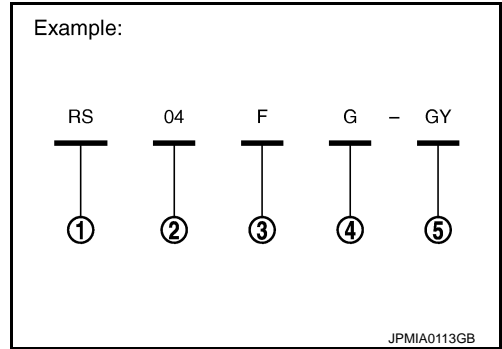

A
B
C
D
E
F
G
H
I
J
K
L
PG
N
O
P

CONNECTOR INFORMATION

< WIRING DIAGRAM >

B Body Harness

INFOID:00000008131345

BODY HARNESS

Connector No.	B1
Connector Name	WIRE TO WIRE
Connector Type	THBDFW-CS16-TM4

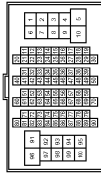

Terminal No.	Color of Wire	Signal Name [Specification]
1	R	-
2	W	-
4	LG	-
5	P	-
6	V	-
7	GR	-
8	Y	-
9	LG	-
10	V	-
11	GR	- [With climate controlled seat] - [With heated seat]
12	P	- [With climate controlled seat] - [With heated seat]
13	BR	-
14	R	-
15	O	-
16	V	-
17	B	-
18	R	-
19	W	-
20	R	-
21	B	-
22	LG	-
23	V	-
24	Y	-
25	G	-
26	GR	-
27	SB	-
28	L/O	-
29	W/L	-
30	SHIELD	-
32	L	-
33	R	-
34	L	-
35	R	-
36	G	-
37	SB	-
41	GR/V	-

Terminal No.	Color of Wire	Signal Name [Specification]
42	W/L	-
45	W	-
47	O	-
48	Y	-
49	BR	-
50	SB	-
51	V	-
52	LG	-
53	G	-
55	GR	-
56	B	- [With 4WAS] - [Without 4WAS]
57	LG	- [With 4WAS] - [Without 4WAS]
58	BR	- [With 4WAS] - [Without 4WAS]
59	Y	- [Without 4WAS]
60	W	-
61	B	-
62	LG	-
63	V	-
65	O	-
66	BR	-
67	V	-
68	LG	-
69	GR	-
70	R	-
72	L	-
73	P	-
74	L	-
75	P	-
76	Y	-
77	R	-
78	W	-
79	G	-
81	LG	-
82	BR	-
83	SB	-
84	Y	-
85	W	-
86	R	-
87	G	-
88	GR	-
91	SB	-
92	G	-
96	Y	-
97	O	-
98	SB	-
99	LG	-

Connector No.	B2
Connector Name	WIRE TO WIRE
Connector Type	NSDFW-CS



Terminal No.	Color of Wire	Signal Name [Specification]
1	SHIELD	-
3	W	-
4	R	-
5	G	-
6	B	-

Connector No.	B3
Connector Name	WIRE TO WIRE
Connector Type	MD2FW-LC



Terminal No.	Color of Wire	Signal Name [Specification]
1	W	-
2	L	-

CONNECTOR INFORMATION

< WIRING DIAGRAM >

BODY HARNESS

Connector No.	B4
Connector Name	WIRE TO WIRE
Connector Type	TH40MW-CS15

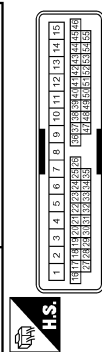

Terminal No.	Color of Wire	Signal Name [Specification]
5	B/W	-
6	L	-
7	R	-
8	B	-
9	W	-
10	LG	-
11	P	-
12	GR	-
13	B/W	-
14	SB	-
15	O	-
16	G	-
17	Y	-
18	BR	-
19	GR	-
20	O	-
21	LG	-
22	L	-
23	SB	-
24	V	-
27	V	-
28	W	-
29	SB	-
30	L	-
31	LG	-
32	O	-
33	V	-
34	BR	-
35	B/R	-
36	P	-
37	BR	-
38	W	-
39	O	-
40	L	-
41	SHIELD	-
42	W/L	-
43	L/O	-
44	R	-

45	Y	-
46	V	-
47	SB	-
48	GR	-
49	LG	-
50	B	-
51	G	-
52	R	-
53	B	-
54	V	-
55	W	-

Connector No.	B5
Connector Name	WIRE TO WIRE
Connector Type	TH24MW-NH

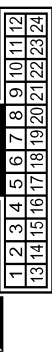

Terminal No.	Color of Wire	Signal Name [Specification]
1	Y	-
3	BR	-
12	V	-
24	SB	-

Connector No.	B6
Connector Name	FUSE BLOCK (J/B)
Connector Type	NS12FBR-CS



Terminal No.	Color of Wire	Signal Name [Specification]
1G	GR	-
2G	G/R	-
4G	L	-
5G	P/L	-
6G	G	-

10G	W	-
11G	W	-
12G	GR	-

Connector No.	B8
Connector Name	WIRE TO WIRE
Connector Type	NS12FW-CS



Terminal No.	Color of Wire	Signal Name [Specification]
4	L	-
5	Y	-
10	W	-
11	G	-
12	SB	-

Connector No.	B9
Connector Name	PRE-DRASH ISCA BELT CONTROL UNIT (DRIVER SIDE)
Connector Type	TH18FW-CS2

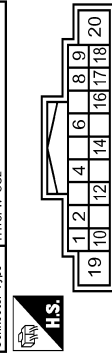

Terminal No.	Color of Wire	Signal Name [Specification]
1	V	SIG BAT
2	G	OUT 1
4	R	CAN LO
6	LG	BUCKLE SW LH NO
8	BR	LOCAL COMM 2
9	SHIELD	SHIELD GND
10	R	SENS POWER 1
12	B	OUT 2
14	L	CAN HI
16	Y	LOCAL COMM 1
17	W	SENS GND 1
18	B	SIG GND

19	Y	MOTOR BAT
20	B	MOTOR GND

Connector No.	B11
Connector Name	WIRE TO WIRE
Connector Type	NS16FW-CS



Terminal No.	Color of Wire	Signal Name [Specification]
1	SB	-
2	B	-
23	L	-
24	R	- [With CAN gateway]
24	P	- [Without CAN gateway]
25	BR	-
26	W	-
27	L	-
28	P	-
29	O	-
30	V	-
31	BR	-
32	LG	-
35	LG	-
40	O	-
41	B	-

Connector No.	B12
Connector Name	SIDE AIR BAG MODULE LH
Connector Type	TK02FY-EX-IV

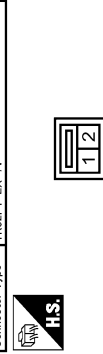

Terminal No.	Color of Wire	Signal Name [Specification]
1	R	-
2	L	-

JRMWC9525GB

A
B
C
D
E
F
G
H
I
J
K
L
PG
N
O
P

CONNECTOR INFORMATION

< WIRING DIAGRAM >

BODY HARNESS

Connector No.	B13
Connector Name	TIRE PRESSURE RECEIVER REAR LH
Connector Type	TR10AFB



Terminal No.	Color of Wire	Signal Name [Specification]
1	W	VCC
2	R	RSSI
3	Y	SIG
4	G	GND

Connector No.	B14
Connector Name	WIRE TO WIRE
Connector Type	TH164FW-NH

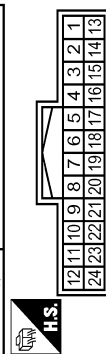

Terminal No.	Color of Wire	Signal Name [Specification]
2	GR/V	-
3	W/L	-
4	R	-
5	SB	-
6	V	-
7	O	-
8	LG	-
9	L	-
10	SB	-
11	W	-
12	V	-
18	G	-
19	Y	-
20	BR	-
21	GR	-
22	O	-
23	LG	-
24	L	-

Connector No.	B15
Connector Name	AIR BAG DIAGNOSIS SENSOR UNIT
Connector Type	NI12ZFT-2V-EX

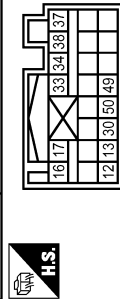

Terminal No.	Color of Wire	Signal Name [Specification]
12	P	PLH (+)
13	G	PLH (-)
16	SB	PLH2 (+)
17	V	PLH2 (-)
30	O	LH BUCKLE SW INPUT
33	R	SLH (+)
34	L	SLH (-)
37	Y	GLH (+)
38	BR	GLH (-)
49	LG	SATELLITE LH (+)
50	GR	SATELLITE LH (-)

Connector No.	B16
Connector Name	FRONT DOOR SWITCH LH
Connector Type	A03FW

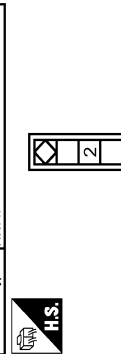

Terminal No.	Color of Wire	Signal Name [Specification]
2	LG	-

Connector No.	B17
Connector Name	AMD CONTROL UNIT
Connector Type	TH116FW-NH

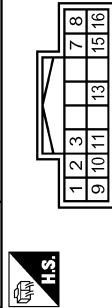

Terminal No.	Color of Wire	Signal Name [Specification]
1	BR	AMD SOL (+)
2	R	AMD SOL (-)
3	W	OIL TEMP (-)
7	Y	IGN
8	L	CAN-H
9	SB	AMD SOL BAT
10	B/Y	GND
11	B/Y	GND
13	LG	OIL TEMP (+)
15	G	VB
16	P	CAN-L

Connector No.	B18
Connector Name	WIRE TO WIRE
Connector Type	NH10FW-CSS10

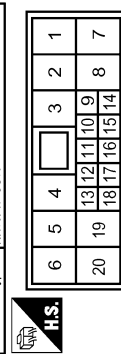

Terminal No.	Color of Wire	Signal Name [Specification]
1	LG	-
2	P	-
3	R	-
4	G	-
7	B	-
8	W	-
9	V	-
10	Y	-
11	L	-
12	Y	-
13	B	-

Connector No.	B20
Connector Name	SATELLITE SENSOR LH
Connector Type	HK02FY-1V-EX-LC

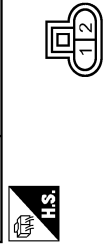

Terminal No.	Color of Wire	Signal Name [Specification]
1	LG	-
2	GR	-

Connector No.	B21
Connector Name	FUEL LEVEL SENSOR UNIT (SUB)
Connector Type	ED2FY-RS

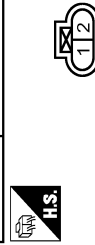

Terminal No.	Color of Wire	Signal Name [Specification]
1	LG	-
2	O	-

Connector No.	B22
Connector Name	CONDENSER
Connector Type	IM01FW-LC



Terminal No.	Color of Wire	Signal Name [Specification]
1	W	-

JRMWC9526GB

CONNECTOR INFORMATION

< WIRING DIAGRAM >

BODY HARNESS

Connector No.	B23
Connector Name	REAR DOOR SWITCH LH
Connector Type	A0SFV

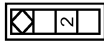

Terminal No.	Color of Wire	Signal Name [Specification]
1	BR	-
2	BR	-

Connector No.	B26
Connector Name	REAR COMBINATION LAMP LH
Connector Type	NS0MNV-CS



Terminal No.	Color of Wire	Signal Name [Specification]
1	L	-
2	P	-
3	GR	-
4	B/R	-

Connector No.	B27
Connector Name	SEAT BELT PRE-TENSIONER LH
Connector Type	ACB02FY



Terminal No.	Color of Wire	Signal Name [Specification]
1	P	-

Terminal No.	2	Color of Wire	G	Signal Name [Specification]	-
--------------	---	---------------	---	-----------------------------	---

Connector No.	B28
Connector Name	CURTAIN AIR BAG MODULE LH
Connector Type	ACB02FY



Terminal No.	Color of Wire	Signal Name [Specification]
1	Y	-
2	BR	-

Connector No.	B29
Connector Name	WIRE TO WIRE
Connector Type	RH04FB



Terminal No.	Color of Wire	Signal Name [Specification]
1	W	-
2	B	-
3	LG	-
4	BR	- [With ICC] - [Without ICC]

Connector No.	B30
Connector Name	WIRE TO WIRE
Connector Type	RFD3MB



Terminal No.	Color of Wire	Signal Name [Specification]
1	GR	-
2	B	-
3	LG	-
4	BR	-

Connector No.	B31
Connector Name	WIRE TO WIRE
Connector Type	NS12PV-CS



Terminal No.	Color of Wire	Signal Name [Specification]
46	L	-
47	B/W	-
48	SHIELD	-
49	B/R	-
50	BR	-
52	O	- [With climate controlled seat] - [Without climate controlled seat]
53	BR	- [With heated seat] - [Without heated seat]
54	P	- [With heated seat] - [Without heated seat]
55	G	- [With climate controlled seat] - [Without climate controlled seat]
56	GR	-
57	R	-
58	B	-

Connector No.	B32
Connector Name	HEIGHT SENSOR
Connector Type	FAZ06FBI

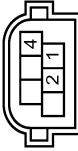

Terminal No.	Color of Wire	Signal Name [Specification]
1	SB	-
2	G	-
4	Y	-

Connector No.	B33
Connector Name	WIRE TO WIRE
Connector Type	NS16FY-CS



Terminal No.	Color of Wire	Signal Name [Specification]
1	P	-
2	L	-
3	O	-
8	GR	-
9	O	-
10	P	-
11	R/L	-
12	P/L	-
13	L	-
14	Y	-

JRMWC9527GB

A B C D E F G H I J K L O P



CONNECTOR INFORMATION

< WIRING DIAGRAM >

BODY HARNESS

Connector No.	B34
Connector Name	REAR WHEEL SENSOR LH
Connector Type	RH02FB



Terminal No.	Color of Wire	Signal Name [Specification]
1	GR	- [With 4WAS]
2	W	- [Without 4WAS]
3	B	-

Connector No.	B35
Connector Name	REAR WHEEL SENSOR RH
Connector Type	RH02FGY



Terminal No.	Color of Wire	Signal Name [Specification]
1	LG	-
2	BR	- [With 4WAS]
3	V	- [Without 4WAS]

Connector No.	B36
Connector Name	4WAS REAR MOTOR
Connector Type	X02FB



Terminal No.	Color of Wire	Signal Name [Specification]
1	W	-
2	V	-

1	R
2	P

Connector No.	B38
Connector Name	REAR WHEEL STEERING ANGLE SENSOR
Connector Type	RSD4FGY-PR



Terminal No.	Color of Wire	Signal Name [Specification]
1	V	-
2	LG	-
3	R	-
4	W	-

Connector No.	B39
Connector Name	SATELLITE SPEAKER LH
Connector Type	TK02FBR



Terminal No.	Color of Wire	Signal Name [Specification]
1	G	-
2	R	-

Connector No.	B40
Connector Name	WIRE TO WIRE
Connector Type	NS16MH-CS



Terminal No.	Color of Wire	Signal Name [Specification]
1	P	-
2	O	-
3	LG	-
4	L	-
5	B/W	-
6	SHIELD	-
9	B	-
10	W	-
11	R	-
12	G	-
13	Y	-
14	BR	-
15	SHIELD	-
16	LG	-

Connector No.	B41
Connector Name	BOSE AMP.
Connector Type	SGA12FBR-SJA2

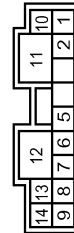

Terminal No.	Color of Wire	Signal Name [Specification]
1	O	SOUND SIGNAL FRONT DOOR WOOFER RH (-)
2	LG	SOUND SIGNAL FRONT DOOR WOOFER RH (-)
5	R	SOUND SIGNAL FRONT DOOR WOOFER LH (-)
6	L	SOUND SIGNAL FRONT DOOR WOOFER LH (-)
7	B/R	GND
8	P/L	SOUND SIGNAL REAR WOOFER (-)
9	W	SOUND SIGNAL FRONT DOOR SPEAKERS & TWEETER (-)
10	V	BATTERY

11	G	BATTERY
12	B/R	GND
13	R/L	SOUND SIGNAL REAR WOOFER (-)
14	B	SOUND SIGNAL FRONT DOOR SPEAKERS & TWEETER (-)

Connector No.	B42
Connector Name	BOSE AMP.
Connector Type	SGA19FBR-SGA4

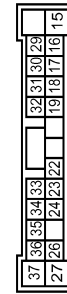

Terminal No.	Color of Wire	Signal Name [Specification]
15	G	AMP. ON SIGNAL
16	G	SOUND SIGNAL REAR DOOR SPEAKER LH (-)
17	W	SOUND SIGNAL FRONT DOOR SPEAKERS & TWEETER (-)
18	B	SOUND SIGNAL FRONT DOOR SPEAKERS & TWEETER (-)
19	B/R	SOUND SIGNAL DRIVER SEAT SPEAKER LH (-)
22	L	SOUND SIGNAL DRIVER SEAT SPEAKER RH (-)
23	Y	SOUND SIGNAL PASSENGER SEAT SPEAKER LH (-)
24	R	SOUND SIGNAL REAR DOOR SPEAKER RH (-)
26	O	SOUND SIGNAL PASSENGER SEAT SPEAKER RH (-)
27	O/L	SOUND SIGNAL SATELLITE SPEAKER LH (-)
29	B	SOUND SIGNAL REAR DOOR SPEAKER LH (-)
30	P	SOUND SIGNAL CENTER SPEAKER (-)
31	V	SOUND SIGNAL CENTER SPEAKER (+)
32	BR	SOUND SIGNAL DRIVER SEAT SPEAKER LH (-)
33	B/W	SOUND SIGNAL DRIVER SEAT SPEAKER RH (-)
34	BR	SOUND SIGNAL PASSENGER SEAT SPEAKER LH (-)
35	G	SOUND SIGNAL REAR DOOR SPEAKER RH (-)
36	W/L	SOUND SIGNAL PASSENGER SEAT SPEAKER RH (-)
37	W	SOUND SIGNAL SATELLITE SPEAKER LH (-)

JRMWC9528.GB

CONNECTOR INFORMATION

< WIRING DIAGRAM >

BODY HARNESS

Connector No.	B50
Connector Name	ADAS CONTROL UNIT
Connector Type	TH18FW-NH1

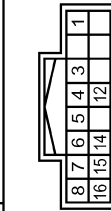

Terminal No.	Color of Wire	Signal Name [Specification]
1	Y	WARNING SYSTEMS SW
3	BR	IBA OFF SW
4	O	WARNING SYSTEMS ON IND
5	SB	BRAKE HOLD RLY DRIVE SIGNAL
6	B/R	GND
7	L	ITS COMM-H
8	P	ITS COMM-L
12	W	WARNING BUZZER
14	L	CAN-H
15	R	CAN-L
16	GR	IGNITION

Connector No.	B51
Connector Name	WIRE TO WIRE
Connector Type	MOBMB-LC

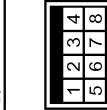

Terminal No.	Color of Wire	Signal Name [Specification]
5	W	-

Connector No.	B52
Connector Name	SIDE RADAR LH
Connector Type	AACB8FB-WP-5P

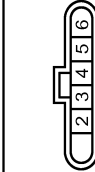

Terminal No.	Color of Wire	Signal Name [Specification]
2	B/Y	GND
3	Y	ITS COMM-L
4	L	ITS COMM-H
5	GR	IGNITION
6	BR	BSW/BSI INDICATOR

Connector No.	B53
Connector Name	4WAS REAR MOTOR RELAY
Connector Type	MSD2FL-M2-LC

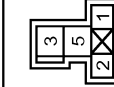

Terminal No.	Color of Wire	Signal Name [Specification]
1	G	-
2	B/Y	-
3	L	-
5	L	-

Connector No.	B54
Connector Name	4WAS MAIN CONTROL UNIT
Connector Type	AS8FW-IM4

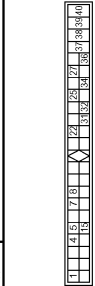

Terminal No.	Color of Wire	Signal Name [Specification]
1	L	CAN-H
4	R	RR-ANG SEN SIG (MAIN)
5	V	RR-ANG SEN SIG PWR SUPPLY
7	LG	RR-ANG SEN SIG (SUB)
8	P	CAN-L
15	W	RR-ANG SEN GND
22	P	STOP LAMP SW
25	G	RR-MTR RELAY
27	R	IGN
31	W/L	4WAS COMMUNICATION-H
32	GR/V	4WAS COMMUNICATION-L
34	B/Y	GND
36	SB	EPS SOL
37	L	RR-MTR PWR SUPPLY
38	R	RR-MTR (RH)
39	P	RR-MTR (LH)
40	B/Y	RR-MTR GND

Connector No.	B55
Connector Name	LAP PRE-TENSIONER LH
Connector Type	ACB02FOR



Terminal No.	Color of Wire	Signal Name [Specification]
1	SB	-
2	V	-

Connector No.	B57
Connector Name	ACTIVE NOISE CONTROL UNIT
Connector Type	TH18FW-CS2

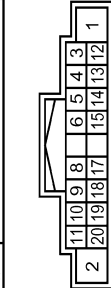

Terminal No.	Color of Wire	Signal Name [Specification]
1	B/R	GND
2	Y	BATTERY
3	Y	SOUND SIGNAL FRONT LH+
4	V	SOUND SIGNAL FRONT RH+
5	LG	SOUND SIGNAL REAR LH+
6	O	SOUND SIGNAL REAR RH+
8	W	SOUND SIGNAL FRONT DOOR SPEAKER & SOAWMWER LH
9	B	SOUND SIGNAL FRONT DOOR SPEAKER & SOAWMWER RH
10	G	SOUND SIGNAL REAR DOOR SPEAKER LH
11	R	SOUND SIGNAL REAR DOOR SPEAKER RH
12	L	SOUND SIGNAL FRONT LH-
13	GR	SOUND SIGNAL FRONT RH-
14	W	SOUND SIGNAL REAR LH-
15	SB	SOUND SIGNAL REAR RH-
17	B	SOUND SIGNAL FRONT DOOR SPEAKER & SOAWMWER LH
18	W	SOUND SIGNAL FRONT DOOR SPEAKER & SOAWMWER RH
19	R	SOUND SIGNAL REAR DOOR SPEAKER LH
20	G	SOUND SIGNAL REAR DOOR SPEAKER RH

JRMWC9530GB

CONNECTOR INFORMATION

< WIRING DIAGRAM >

BODY HARNESS

Connector No.	B58
Connector Name	ACTIVE NOISE CONTROL UNIT
Connector Type	TH1BFW-NH

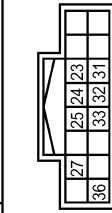

Terminal No.	Color of Wire	Signal Name [Specification]
23	Y	FRONT MICROPHONE - FOR ACTIVE NOISE CONTROL SYSTEM
24	L	REAR MICROPHONE - FOR ACTIVE NOISE CONTROL SYSTEM
25	P	STEP LAMP CONT
27	O	ENGINE TYPE
31	BR	FRONT MICROPHONE - FOR ACTIVE NOISE CONTROL SYSTEM
32	LG	REAR MICROPHONE - FOR ACTIVE NOISE CONTROL SYSTEM
33	SB	ENGINE SPEED OUTPUT SIGNAL
36	V	ACC

Connector No.	B63
Connector Name	OUTSIDE KEY ANTENNA (REAR BUMPER)
Connector Type	RK02FL



Terminal No.	Color of Wire	Signal Name [Specification]
1	R	ANT+
2	GR	ANT-

Connector No.	B68
Connector Name	WIRE TO WIRE
Connector Type	FR08FB

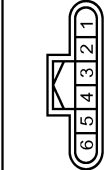

Terminal No.	Color of Wire	Signal Name [Specification]
2	B	-
3	W	-
4	R	-
5	G	-
6	Y	-

Connector No.	B71
Connector Name	WIRE TO WIRE
Connector Type	FR08FB-PR



Terminal No.	Color of Wire	Signal Name [Specification]
1	R	-
2	G	-
3	LG	-
5	W	-
6	V	-

Connector No.	B72
Connector Name	WIRE TO WIRE
Connector Type	FR08MB



Terminal No.	Color of Wire	Signal Name [Specification]
1	G	-
2	G	-
3	P	-
5	W	-
6	V	-

Connector No.	B73
Connector Name	EVAP CONTROL SYSTEM PRESSURE SENSOR
Connector Type	ED03FGY-RS

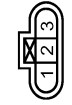

Terminal No.	Color of Wire	Signal Name [Specification]
1	V	-
2	P	-
3	G	-

Connector No.	B74
Connector Name	EVAP CANISTER VENT CONTROL VALVE
Connector Type	ED02FB-RS



Terminal No.	Color of Wire	Signal Name [Specification]
1	W	POWER
2	G	GND

Connector No.	B80
Connector Name	WIRE TO WIRE
Connector Type	TK08MW-1V

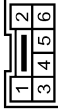

Terminal No.	Color of Wire	Signal Name [Specification]
3	P	-
4	G	-
5	SB	-
6	B/R	-

Connector No.	B81
Connector Name	WIRE TO WIRE
Connector Type	TK08FW-1V



Terminal No.	Color of Wire	Signal Name [Specification]
3	R/W	-
4	P	-
5	L	-
6	BR	-

A
B
C
D
E
F
G
H
I
J
K
L
PG
N
O
P

CONNECTOR INFORMATION

< WIRING DIAGRAM >

BODY HARNESS

Connector No.	B82
Connector Name	REAR SUNSHADE CONTROL UNIT
Connector Type	AMP 174923-1

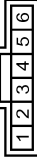

Terminal No.	Color of Wire	Signal Name [Specification]
1	R/W	IGN PWR SPLY
2	BR	GND
4	L	RR SUNSHADE SW
6	P	REVERSE

Connector No.	B83
Connector Name	REAR SUNSHADE CONTROL UNIT
Connector Type	AMP 174463-1



Terminal No.	Color of Wire	Signal Name [Specification]
7	W	RR SUNSHADE OPEN
8	G	RR SUNSHADE CLOSE

Connector No.	B100
Connector Name	WIRE TO WIRE
Connector Type	TH12MW-NH

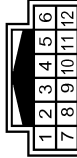

Terminal No.	Color of Wire	Signal Name [Specification]

1	LG	-
2	V	-
3	SHIELD	-
4	G	-
5	R	-
6	SHIELD	-
10	W/L	-
11	W/R	-
12	SHIELD	-

Connector No.	B200
Connector Name	WIRE TO WIRE
Connector Type	TH16MW-NH

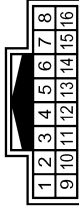

Terminal No.	Color of Wire	Signal Name [Specification]
1	W/L	-
2	SHIELD	-
3	GR/V	-
4	SHIELD	-
5	B	-
6	W	-
7	R	-
8	G	-
9	SHIELD	-
10	L/R	-
11	L/W	-
12	L	-
13	SHIELD	-
14	R	-
15	W	-
16	B	-

Connector No.	B201
Connector Name	WIRE TO WIRE
Connector Type	TH16MW-CS16-TM4

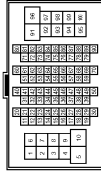

Terminal No.	Color of Wire	Signal Name [Specification]
3	R	-
6	R	-
13	Y	-
17	GR	-
18	P	-
19	BR	-
20	GR	-
21	Y	-
22	GR	-
23	R	-
24	V	-
25	B	-
26	W	-
27	O	-
28	V	-
29	P	-
30	O	-
31	B/R	-
32	Y	-
40	SHIELD	-
41	W/R	-
42	V	-
44	P	-
45	SB	-
46	R	- [With climate controlled seat]
47	G	- [With heated seat]
47	GR	- [With climate controlled seat]
48	V	- [With heated seat]
49	O	-
50	R	-
51	GR	-
52	LG	-
53	P	-
56	P	-
57	W	-
58	O	-
59	Y	-

61	SB	-
62	L	-
63	W	-
66	L	-
67	Y	-
68	SB	-
69	B	-
70	R	-
76	SHIELD	-
77	G	-
78	R	-
79	P	-
80	G	-
81	O	-
82	BR	-
83	GR	-
84	V	-
85	LG	-
86	W	-
87	O	-
88	Y	-
89	SB	-
90	L	-
91	BR	-
93	Y	- [With climate controlled seat]
93	O	- [With heated seat]
94	GR	-
96	W	-
97	P	-
98	LG	-
99	LG	-
100	Y	-

CONNECTOR INFORMATION

< WIRING DIAGRAM >

BODY HARNESS

Connector No.	B204
Connector Name	WIRE TO WIRE
Connector Type	THHMW-CS15

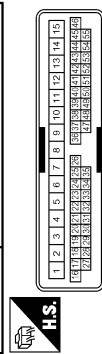

Terminal No.	Color of Wire	Signal Name [Specification]
2	B/W	-
3	B/W	-
5	Y	-
9	R	-
10	P	-
11	V	-
12	Y	-
13	BR	-
14	LG	-
15	GR	-
16	G	-
17	O	-
18	BR	-
19	GR	-
20	V	-
21	LG	-
22	W	-
23	O	-
24	Y	-
25	SB	-
26	L	-
32	G	-
33	R	-
34	SHIELD	-
35	P	-
36	B/R	-
37	BR	-
38	SB	-
39	P	-
44	SB	-
45	R	-
46	B	-

Connector No.	B206
Connector Name	JUMPING CONNECTOR
Connector Type	TMI0FB

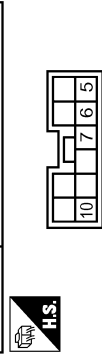

Terminal No.	Color of Wire	Signal Name [Specification]
5	B/R	-
6	B	-
7	W	-
10	BR	-

Connector No.	B207
Connector Name	JUMPING CONNECTOR
Connector Type	TMI0MB



Terminal No.	Color of Wire	Signal Name [Specification]
15	W	-
18	W	-
19	B	-
20	B	-

Connector No.	B208
Connector Name	SEAT BELT PRE-TENSIONER RH
Connector Type	ACB02FY

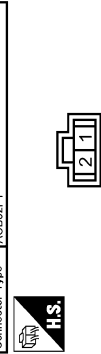

Terminal No.	Color of Wire	Signal Name [Specification]
1	W	-
2	L	-

Connector No.	B209
Connector Name	CURTAIN AIR BAG MODULE RH
Connector Type	ACB02FY

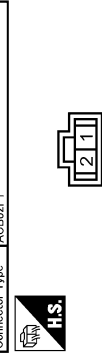

Terminal No.	Color of Wire	Signal Name [Specification]
1	Y	-
2	BR	-

Connector No.	B211
Connector Name	WIRE TO WIRE
Connector Type	TK10FW-NS5



Terminal No.	Color of Wire	Signal Name [Specification]
1	BR	-
2	B	-
35	G	-
40	L	-
41	B	-
46	Y	-
47	BR	-
48	SHIELD	-
49	L	-
50	B/W	-
52	SB	-
53	O	-
54	R	-
54	B	-

55	Y	-
56	G	-
57	V	-
58	B	- [With climate controlled seat]
58	GR	- [With heated seat]

Connector No.	B212
Connector Name	SIDE AIR BAG MODULE RH
Connector Type	TK02FY-EX-1V

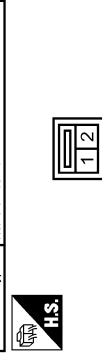

Terminal No.	Color of Wire	Signal Name [Specification]
1	LG	-
2	B	-

Connector No.	B213
Connector Name	TIRE PRESSURE RECEIVER REAR RH
Connector Type	RH04FB

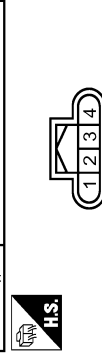

Terminal No.	Color of Wire	Signal Name [Specification]
1	O	VCC
2	W	RSSI
3	P	SIG
4	Y	GND

JRMWC9533GB

A
B
C
D
E
F
G
H
I
J
K
L
PG
N
O
P

CONNECTOR INFORMATION

< WIRING DIAGRAM >

BODY HARNESS

Connector No.	B214
Connector Name	DRIVER SEAT BELT SYSTEM CONTROL UNIT
Connector Type	TH24FW-NH



Terminal No.	Color of Wire	Signal Name [Specification]
2	V	COMMUNICATION
4	R	IGN
5	B	GND

Connector No.	B215
Connector Name	AIR BAG DIAGNOSIS SENSOR UNIT
Connector Type	NH22PY-TV-EX

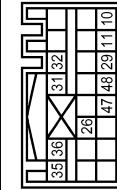

Terminal No.	Color of Wire	Signal Name [Specification]
10	W	PRH (+)
11	L	PRH (-)
26	V	ODS INPUT
29	L	RH BUCKLE SW INPUT
31	LG	SRH (+)
32	B	SRH (-)
36	Y	CRH (+)
36	BR	CRH (-)
47	G	SATELLITE RH (+)
48	R	SATELLITE RH (-)

Connector No.	B216
Connector Name	FRONT DOOR SWITCH RH
Connector Type	A03FW



Terminal No.	Color of Wire	Signal Name [Specification]
2	GR	-

Connector No.	B218
Connector Name	WIRE TO WIRE
Connector Type	NH10FW-GS10

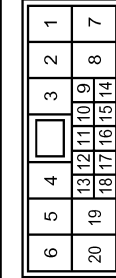

Terminal No.	Color of Wire	Signal Name [Specification]
1	LG	-
2	GR	-
3	O	-
4	P	-
7	B	-
8	P	-
9	O	-
10	W	-
11	O	-
12	Y	-
13	B	-

Connector No.	B220
Connector Name	SATELLITE SENSOR RH
Connector Type	NH02FY-TV-EX-LC



Terminal No.	Color of Wire	Signal Name [Specification]
1	G	-
2	R	-

Connector No.	B221
Connector Name	FUEL PUMP CONTROL MODULE
Connector Type	TM10FB



Terminal No.	Color of Wire	Signal Name [Specification]
5	B/R	-
6	B	-
7	W	-
8	P	-
9	GR	-
10	BR	-

Connector No.	B222
Connector Name	WIRE TO WIRE
Connector Type	TH24FW-NH

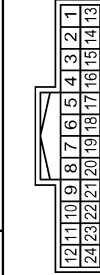

Terminal No.	Color of Wire	Signal Name [Specification]
1	LG	-
3	V	-
12	P	-
24	SB	-

Connector No.	B223
Connector Name	REAR DOOR SWITCH RH
Connector Type	A03FW



Terminal No.	2
Color of Wire	BR
Signal Name [Specification]	-

Connector No.	B227
Connector Name	PRE-CRASH SEAT BELT CONTROL UNIT (PASSENGER SEAT)
Connector Type	TH18FW-CS2

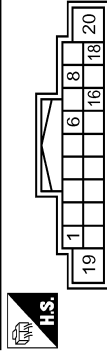

Terminal No.	Color of Wire	Signal Name [Specification]
1	P	SIG BAT
6	G	BUCKLE SW RH NO
8	V	LOCAL COMM 2
16	LG	LOCAL COMM 1
18	B	SIG GND
19	W	MOTOR BAT
20	B	MOTOR GND

JRMWC9534GB

CONNECTOR INFORMATION

< WIRING DIAGRAM >

BODY HARNESS

Connector No.	B230
Connector Name	WIRE TO WIRE
Connector Type	M08FE-LC



Terminal No.	Color of Wire	Signal Name [Specification]
5	BR	-

Connector No.	B236
Connector Name	SATELLITE RADIO TUNER
Connector Type	XA6FW

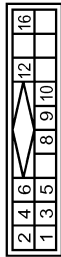

Terminal No.	Color of Wire	Signal Name [Specification]
1	G	SATELLITE RADIO SOUND SIGNAL LH (-)
2	R	SATELLITE RADIO SOUND SIGNAL LH (+)
3	W	SATELLITE RADIO SOUND SIGNAL RH (-)
4	B	SATELLITE RADIO SOUND SIGNAL RH (+)
5	SHIELD	SHIELD
6	SHIELD	SHIELD
8	R	REQUEST (SAT->CONT)
9	B	COMM (SAT->CONT)
10	W	COMM (CONT->SAT)
12	Y	BATTERY
16	V	ACC

Connector No.	B237
Connector Name	TEL ADAPTER UNIT
Connector Type	TH82FW-NH

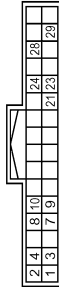

Terminal No.	Color of Wire	Signal Name [Specification]
1	LG	BATTERY
2	L	ACC
3	P	IGNITION
4	B/R	GND
7	W/R	MICROPHONE SIGNAL
8	SHIELD	MICROPHONE GND
9	W/L	TEL VOICE SIGNAL (+)
10	GR/V	TEL VOICE SIGNAL (-)
21	B/R	CONTROL SIGNAL
23	B/R	CONTROL SIGNAL
24	B/R	CONTROL SIGNAL
28	W	VEHICLE SPEED SIGNAL (8-PULSE)
29	B/R	MICROPHONE VCC

Connector No.	B238
Connector Name	TEL ADAPTER UNIT
Connector Type	TH88FW-NH

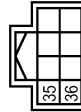

Terminal No.	Color of Wire	Signal Name [Specification]
35	GR	AV COMM (H)
36	SB	AV COMM (L)

Connector No.	B239
Connector Name	SATELLITE SPEAKER RH
Connector Type	TK82FBR



Terminal No.	Color of Wire	Signal Name [Specification]
1	V	-
2	P	-

Connector No.	B240
Connector Name	WIRE TO WIRE
Connector Type	NS18FV-CS

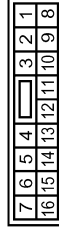

Terminal No.	Color of Wire	Signal Name [Specification]
1	GR	-
2	V	-
3	P	-
4	Y	-
5	BR	-
6	SHIELD	-
9	BR	-
10	Y	-
11	P	-
12	O	-
13	L	-
14	B/W	-
15	SHIELD	-
16	LG	-

Connector No.	B241
Connector Name	FUEL LEVEL SENSOR UNIT AND FUEL PUMP MARK
Connector Type	ED8FGY-RS



Terminal No.	Color of Wire	Signal Name [Specification]
1	W	-
2	O	-
3	B	-
4	P	-
5	B	-

Connector No.	B242
Connector Name	FUEL LID LOCK ACTUATOR
Connector Type	M04FW-LC



Terminal No.	Color of Wire	Signal Name [Specification]
1	LG	-
2	GR	-

JRMWC9535GB

A
B
C
D
E
F
G
H
I
J
K
L
PG
N
O
P

CONNECTOR INFORMATION

< WIRING DIAGRAM >

BODY HARNESS

Connector No.	B243
Connector Name	REAR WOOFER
Connector Type	MS2PW-LC



Terminal No.	Color of Wire	Signal Name [Specification]
1	P/L	-
2	R/L	-

Connector No.	B245
Connector Name	WIRE TO WIRE
Connector Type	NS18MGY-CS



Terminal No.	Color of Wire	Signal Name [Specification]
1	P	-
2	O	-
3	Y	-
8	G	-
9	V	-
10	P	-
11	R/L	-
12	P/L	-
13	L	-
14	Y	-

Connector No.	B232
Connector Name	SIDE RADAR RH
Connector Type	AAC88FB-WP

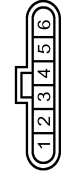

Terminal No.	Color of Wire	Signal Name [Specification]
1	B/R	RIGHT/LEFT SWITCHING SIGNAL
2	B/R	GND
3	Y	ITS COMM-L
4	L	ITS COMM-H
5	G	IGNITION
6	BR	BSW/BSI INDICATOR

Connector No.	B260
Connector Name	REAR COMBINATION LAMP RH
Connector Type	NS24MW-CS



Terminal No.	Color of Wire	Signal Name [Specification]
1	O	-
2	P	-
3	V	-
4	B/R	-

Connector No.	B271
Connector Name	WIRE TO WIRE
Connector Type	FR108MB



Terminal No.	Color of Wire	Signal Name [Specification]
2	B	-
3	W	-
4	R	-
5	G	-
6	Y	-

Connector No.	B272
Connector Name	CORNER SENSOR (RR)
Connector Type	YDX02FB



Terminal No.	Color of Wire	Signal Name [Specification]
1	B	-
2	Y	-

Connector No.	B273
Connector Name	CENTER SENSOR (RR)
Connector Type	YDX02FB



Terminal No.	Color of Wire	Signal Name [Specification]
1	R	-
2	Y	-

Connector No.	B274
Connector Name	CENTER SENSOR (RL)
Connector Type	YDX02FB



Terminal No.	Color of Wire	Signal Name [Specification]
1	G	-
2	Y	-

Connector No.	B275
Connector Name	CORNER SENSOR (RL)
Connector Type	YDX02FB



Terminal No.	Color of Wire	Signal Name [Specification]
1	W	-
2	Y	-

JRMWC9536GB

CONNECTOR INFORMATION

< WIRING DIAGRAM >

BODY HARNESS

Connector No.	B276
Connector Name	WIRE TO WIRE
Connector Type	NS12MW-CS



1	2	3	4	5	6	7		
8	9	10	11	12	13	14	15	16

Terminal No.	Color of Wire	Signal Name [Specification]
1	R	-
2	GR	-
3	V	-
5	W	-
6	R	-
8	B	-
9	O	-
10	B/R	-
11	L	-
12	L/W	-
13	L/R	-
14	B/R	-
15	Y	-

Connector No.	B471
Connector Name	REAR WINDOW DEFOGGER
Connector Type	P01FB-A



1

Terminal No.	Color of Wire	Signal Name [Specification]
1	-	-

Connector No.	B472
Connector Name	REAR WINDOW DEFOGGER
Connector Type	P01FB-A



2

Terminal No.	Color of Wire	Signal Name [Specification]
2	-	-

Connector No.	B474
Connector Name	TEL ADAPTER UNIT
Connector Type	GT16C-1S-HU



33	34
----	----

Terminal No.	Color of Wire	Signal Name [Specification]
33	-	TEL ANTENNA
34	SHIELD	SHIELD

Connector No.	B482
Connector Name	SATELLITE RADIO TUNER
Connector Type	FAK8A



33	34
----	----

Terminal No.	Color of Wire	Signal Name [Specification]
33	-	SATELLITE RADIO ANTENNA
34	SHIELD	SHIELD

Connector No.	B483
Connector Name	SATELLITE RADIO ANTENNA
Connector Type	GT16C-1PP-HU



1	2
---	---

Terminal No.	Color of Wire	Signal Name [Specification]
1	-	-
2	SHIELD	-

Connector No.	B501
Connector Name	WIRE TO WIRE
Connector Type	NS12MMH-CS



24	23	34	32	31	30	29		
40	41	35	28	2	27	1	26	25

Terminal No.	Color of Wire	Signal Name [Specification]
1	R	-
2	B	-
23	P	-
24	P/L	-
25	G/O	-
26	L/O	-
27	V	-
28	V/W	-
29	L	-
30	BR	-
31	BR/W	-
32	W/L	-
35	W/Y	-
40	W/G	-
41	GR	-

Connector No.	B503
Connector Name	WIRE TO WIRE
Connector Type	NS12MM-CS



57	56	55	47	46		
54	53	58	52	50	49	48

Terminal No.	Color of Wire	Signal Name [Specification]
46	R	-
47	G	-
48	R/Y	-
49	P	-
50	L	-
52	L/B	- [With climate controlled seat]
53	Y/W	- [With heated seat]
53	LG/R	- [With climate controlled seat]
54	Y	- [With heated seat]
54	LG/B	- [With climate controlled seat]
55	G/R	-
56	V	-
57	B/P	-
58	B	-

Connector No.	B507
Connector Name	RECLINING MOTOR
Connector Type	SUMITOMO 618P-D265



5	6	
20	33	43

Terminal No.	Color of Wire	Signal Name [Specification]
5	V	-
6	R/L	-
20	R/Y	-
33	W	-
43	B/W	-

JRMWC9537GB

A B C D E F G H I J K L N O P PG

CONNECTOR INFORMATION

< WIRING DIAGRAM >

BODY HARNESS

Connector No.	B510
Connector Name	LIFTING MOTOR (REAR)
Connector Type	Type 888182



Terminal No.	Color of Wire	Signal Name [Specification]
7	L	-
8	L/W	-
21	L/Y	-
44	Y/G	-

Connector No.	B512
Connector Name	LIFTING MOTOR (FRONT)
Connector Type	Type 888182



Terminal No.	Color of Wire	Signal Name [Specification]
9	L/R	-
10	L/B	-
22	BR/Y	-
45	P/B	-

Connector No.	B513
Connector Name	DRIVER SEAT CONTROL UNIT
Connector Type	NS12FW-CS

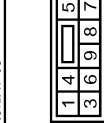

Terminal No.	Color of Wire	Signal Name [Specification]
1	R	BAT (PTC)
2	B	GND
3	G	SLIDE MOTOR (FORWARD)
4	G/R	SLIDE MOTOR (BACKWARD)
5	V	RECLINER MOTOR (FORWARD)
6	R/L	RECLINER MOTOR (BACKWARD)
7	L	REAR LIFTER MOTOR (DOWNWARD)
8	L/W	REAR LIFTER MOTOR (UPWARD)
9	L/R	FRONT LIFTER MOTOR (UPWARD)
10	L/B	FRONT LIFTER MOTOR (DOWNWARD)

Connector No.	B514
Connector Name	DRIVER SEAT CONTROL UNIT
Connector Type	TH32FW-NH

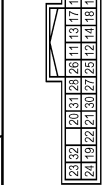

Terminal No.	Color of Wire	Signal Name [Specification]
11	G/B	SLIDE SW (BACKWARD)
12	G/W	SLIDE SW (FORWARD)
13	R/G	RECLINER SW (BACKWARD)
14	R/W	RECLINER SW (FORWARD)
15	Y/B	REAR LIFTER SW (DOWNWARD)
16	Y/R	REAR LIFTER SW (UPWARD)
17	LG/B	FRONT LIFTER SW (DOWNWARD)
18	LG/R	FRONT LIFTER SW (UPWARD)
19	G/Y	PULSE (SLIDE)
20	R/Y	PULSE (REAR LIFTER)
21	Y	PULSE (FRONT LIFTER)
22	R	PULSE (FRONT LIFTER)
23	D	CAN-H
24	P/L	CAN-L
25	G/O	IND 1
26	L/O	IND 2
27	V	ADDRESS 1
28	V/W	ADDRESS 2
29	L	SET SW
30	BR	PULSE(TILT)
31	BR/W	PULSE(TELESCOPIC)
32	W/L	UART (TX/RX)
33	W	POWER SUPPLY (ENCODER)

Connector No.	B515
Connector Name	LIFTING SENSOR CONTROL UNIT
Connector Type	YAZAKI 7183-6086

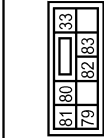

Terminal No.	Color of Wire	Signal Name [Specification]
33	W	-
79	R	-
80	L/Y	-
81	BR/Y	-
82	Y	-
83	B	-

Connector No.	B516
Connector Name	LUMBAR SUPPORT SWITCH
Connector Type	NS04FW-CS

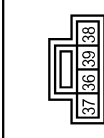

Terminal No.	Color of Wire	Signal Name [Specification]
37	LG	-
38	Y/W	-
39	Y	-

Connector No.	B517
Connector Name	LUMBAR SUPPORT MOTOR
Connector Type	YAZAKI 7283-1020

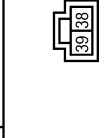

Terminal No.	Color of Wire	Signal Name [Specification]
38	Y/W	-
39	Y	-

Connector No.	B518
Connector Name	POWER SEAT SWITCH
Connector Type	NS10FW-CS

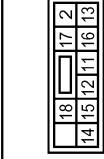

Terminal No.	Color of Wire	Signal Name [Specification]
2	B	-
11	G/B	-
12	G/W	-
13	R/G	-
14	R/W	-
15	Y/B	-
16	Y/B	-
17	LG/B	-
18	LG/R	-

JRMWC9538GB

CONNECTOR INFORMATION

< WIRING DIAGRAM >

BODY HARNESS

Connector No.	B519
Connector Name	SLIDING MOTOR
Connector Type	YAZAKI 7283-1060



19	42	33	4	3
----	----	----	---	---

Terminal No.	Color of Wire	Signal Name [Specification]
3	G	-
4	G/R	-
19	G/Y	-
33	W	-
42	W/B	-

Connector No.	B520
Connector Name	WIRE TO WIRE
Connector Type	NSIDFW-CS



8	7	38	39
9	10	3	4
15	16		

Terminal No.	Color of Wire	Signal Name [Specification]
3	G	-
4	G/R	-
5	V	-
6	R/L	-
7	L	-
8	L/W	-
9	L/R	-
10	L/B	-
38	Y/W	-
39	Y	-

Connector No.	B521
Connector Name	WIRE TO WIRE
Connector Type	NSIDMW-CS



39	38	7	8
6	5	4	3
10	9		

Terminal No.	Color of Wire	Signal Name [Specification]
3	G	-
4	G/R	-
5	V	-
6	R/L	-
7	L	-
8	L/W	-
9	L/R	-
10	L/B	-
38	Y/W	-
39	Y	-

Connector No.	B523
Connector Name	SEAT BELT BUCKLE SWITCH
Connector Type	A03MW-P-B



40	41	35
----	----	----

Terminal No.	Color of Wire	Signal Name [Specification]
35	W/Y	-
40	W/G	-
41	GR	-

Connector No.	B524
Connector Name	DRIVER SEAT SPEAKER RH
Connector Type	TK03FW



48	47	46
----	----	----

Terminal No.	Color of Wire	Signal Name [Specification]
46	R	-
47	G	-
48	R/Y	-

Connector No.	B525
Connector Name	DRIVER SEAT SPEAKER LH
Connector Type	TK03FW



48	50	49
----	----	----

Terminal No.	Color of Wire	Signal Name [Specification]
48	R/Y	-
49	P	-
50	L	-

Connector No.	B528
Connector Name	CLIMATE CONTROLLED SEAT CONTROL UNIT
Connector Type	DELPHI 1532741



60	62	61	59	55	58
----	----	----	----	----	----

Terminal No.	Color of Wire	Signal Name [Specification]

55	G/R	VBAATT
58	B	GROUND
59	LG/R	BACK TED-HEAT (-COOL)
60	LG/B	BACK TED-HEAT (-COOL)
61	Y/R	CUSH TED-HEAT (-COOL)
62	B/R	CUSH TED-HEAT (-COOL)

Connector No.	B529
Connector Name	CLIMATE CONTROLLED SEAT CONTROL UNIT
Connector Type	DELPHI 15408141

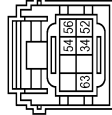

Terminal No.	Color of Wire	Signal Name [Specification]
52	L/B	HEAT/COOL SW RESISTOR PWR
54	Y	HEAT SWITCH INPUT
56	V	COOL SWITCH INPUT
63	R	IGNITION RUN

Connector No.	B530
Connector Name	CLIMATE CONTROLLED SEAT CONTROL UNIT
Connector Type	DELPHI 15394150

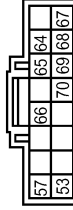

Terminal No.	Color of Wire	Signal Name [Specification]
53	Y/W	COOL INDICATOR
57	B/P	HEAT INDICATOR
64	W/R	VM 1 (BLOWER POWER)
65	W/B	BLOWER-
66	Y/G	VSP 1 (SPEED CONTROL)
67	L/R	BACK SENSOR
68	L	BACK SENSOR RETURN
69	G/B	CUSHION SENSOR
70	G/W	CUSHION SENSOR RETURN

A
B
C
D
E
F
G
H
I
J
K
L
N
O
P

PG

JRMWC9539GB

CONNECTOR INFORMATION

< WIRING DIAGRAM >

BODY HARNESS

Connector No.	B531
Connector Name	CLIMATE CONTROLLED SEAT BLOWER MOTOR
Connector Type	YAZAKI 7283-5830



Terminal No.	Color of Wire	Signal Name [Specification]
64	W/R	-
65	W/B	-
66	Y/G	-



Connector No.	B532
Connector Name	SEATBACK THERMAL ELECTRIC UNIT
Connector Type	SUMITOMO 6058-2183

Terminal No.	Color of Wire	Signal Name [Specification]
59	LG/R	-
60	LG/B	-
67	L/R	-
68	L	-



Connector No.	B533
Connector Name	SEAT CUSHION THERMAL ELECTRIC UNIT
Connector Type	SUMITOMO 6058-2183

Terminal No.	Color of Wire	Signal Name [Specification]
61	Y/R	-
62	B/R	-
69	G/B	-
70	G/W	-

Connector No.	B534
Connector Name	SEAT CUSHION HEATER
Connector Type	NSD2FN-CS



Terminal No.	Color of Wire	Signal Name [Specification]
72	LG/B	-
73	LG/R	-
74	B	-
77	R	-
78	LG/Y	-

Connector No.	B535
Connector Name	SEATBACK HEATER
Connector Type	NSD2FN-CS



Terminal No.	Color of Wire	Signal Name [Specification]
71	R/W	-
78	LG/Y	-

Connector No.	B551
Connector Name	WIRE TO WIRE
Connector Type	TK (OMP)-NS



Terminal No.	Color of Wire	Signal Name [Specification]
1	R	-
2	B	-
35	W/Y	-
40	W/G	-
41	GR	-
46	R	-
47	G	-
48	R/Y	-
49	P	-
50	L	-
52	L/B	-
53	Y/W	- [With climate controlled seat]
53	R/W	- [With climate controlled seat]
54	Y	- [With climate controlled seat]
54	B/W	- [With heated seat]
55	G/R	- [With climate controlled seat]
55	LG/R	- [With heated seat]
56	V	-
57	B/P	-
58	B/W	- [With climate controlled seat]
58	LG/B	- [With heated seat]

Connector No.	B553
Connector Name	SEAT BELT BUCKLE SWITCH
Connector Type	A03MN-P-B



Terminal No.	Color of Wire	Signal Name [Specification]
35	W/Y	-

40	W/G	-
41	GR	-

Connector No.	B555
Connector Name	RECLINING MOTOR
Connector Type	SUMITOMO 6189-0706



Terminal No.	Color of Wire	Signal Name [Specification]
5	V	-
6	P	-

Connector No.	B558
Connector Name	CLIMATE CONTROLLED SEAT CONTROL UNIT
Connector Type	DELPHI I5332141



Terminal No.	Color of Wire	Signal Name [Specification]
55	R/L	VBA1T
58	B/W	GROUND
59	LG/R	BACK TED-HEAT (-COOL)
60	LG/B	BACK TED-HEAT (-COOL)
61	Y/R	CUSH TED-HEAT (-COOL)
62	B/R	CUSH TED-HEAT (-COOL)

JRMWC9540GB

CONNECTOR INFORMATION

< WIRING DIAGRAM >

BODY HARNESS

Connector No.	B559	Connector No.	B561	Connector No.	B566	Connector No.	B567
Connector Name	CLIMATE CONTROLLED SEAT CONTROL UNIT	Connector Name	CLIMATE CONTROLLED SEAT BLOWER MOTOR	Connector Name	CLIMATE CONTROLLED SEAT BLOWER MOTOR	Connector Name	LUMBAR SUPPORT SWITCH
Connector Type	DELPHI 15408141	Connector Type	YAZAKI 7283-5630	Connector Type	YAZAKI 7283-5630	Connector Type	NS34FW-CS

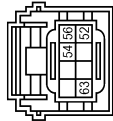

Terminal No.	Color of Wire	Signal Name [Specification]	Terminal No.	Color of Wire	Signal Name [Specification]	Terminal No.	Color of Wire	Signal Name [Specification]
52	L/B	HEAT/COOL SW RESISTOR PMR	64	W/R	-	36	R	-
54	Y	HEAT SWITCH INPUT	65	W/B	-	37	LG	-
56	V	COOL SWITCH INPUT	66	Y/G	-	38	Y/W	-
63	R	IGNITION RUN	67	Y/G	-	39	Y	-

Connector No.	B560	Connector No.	B562	Connector No.	B564	Connector No.	B565
Connector Name	CLIMATE CONTROLLED SEAT CONTROL UNIT	Connector Name	SEATBACK THERMAL ELECTRIC UNIT	Connector Name	PASSENGER SEAT SPEAKER RH	Connector Name	PASSENGER SEAT SPEAKER LH
Connector Type	DELPHI 15394150	Connector Type	SUMITOMO 0096-2163	Connector Type	TK03FW	Connector Type	TK03FW

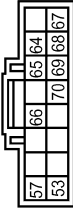

Terminal No.	Color of Wire	Signal Name [Specification]	Terminal No.	Color of Wire	Signal Name [Specification]	Terminal No.	Color of Wire	Signal Name [Specification]
53	Y/W	COOL INDICATOR	59	LG/R	-	46	R	-
57	B/P	HEAT INDICATOR	60	LG/B	-	47	G	-
64	W/R	VM 1 (BLOWER POWER)	67	L/R	-	48	R/Y	-
65	W/B	BLOWER-	68	L	-	49	P	-
66	Y/G	VSP 1 (SPEED CONTROL)	69	L	-	50	L	-
67	L/R	BACK SENSOR	70	G/W	-			
68	L	BACK SENSOR-RETURN						
69	G/B	CUSHION SENSOR						
70	G/W	CUSHION SENSOR RETURN						

JRMWC9541.GB

A
B
C
D
E
F
G
H
I
J
K
L
PG
N
O
P

CONNECTOR INFORMATION

< WIRING DIAGRAM >

BODY HARNESS

Connector No.	B568
Connector Name	POWER SEAT SWITCH
Connector Type	NSUDPW-CS



2	17	18	1
14	16	12	11
15	13		

Terminal No.	Color of Wire	Signal Name [Specification]
1	R	-
2	B	-
11	G/B	-
12	G/W	-
13	R/G	-
14	R/W	-
15	Y/B	-
16	Y/R	-
17	LG/B	-
18	LG/R	-

Connector No.	B569
Connector Name	SLIDING MOTOR
Connector Type	YAZAKI 7283-1060



4	3
---	---

Terminal No.	Color of Wire	Signal Name [Specification]
3	G	-
4	G/R	-

Connector No.	B570
Connector Name	LIFTING MOTOR (FRONT)
Connector Type	Type 988182



9	10
---	----

Terminal No.	Color of Wire	Signal Name [Specification]
9	L/R	-
10	L/B	-

Connector No.	B571
Connector Name	LIFTING MOTOR (REAR)
Connector Type	Type 988182



8	7
---	---

Terminal No.	Color of Wire	Signal Name [Specification]
7	L	-
8	L/W	-

Connector No.	B572
Connector Name	WIRE TO WIRE
Connector Type	NSUDPW-CS



8	7	38	39
9	10	3	4
5	6		

Terminal No.	Color of Wire	Signal Name [Specification]
3	G/W	-
4	G/B	-

5	R/W	-
6	R/G	-
7	Y/B	-
8	Y/R	-
9	LG/R	-
10	LG/B	-
38	Y/W	-
39	Y	-

Connector No.	B573
Connector Name	WIRE TO WIRE
Connector Type	NSUDPW-CS



39	38	7	8
6	5	4	3
10	9		

Terminal No.	Color of Wire	Signal Name [Specification]
3	G	-
4	G/R	-
5	V	-
6	R/L	-
7	L	-
8	L/W	-
9	L/R	-
10	L/B	-
38	Y/W	-
39	Y	-

Connector No.	B574
Connector Name	SEAT CUSHION HEATER
Connector Type	NSUDPW-CS



78	77	74	73
----	----	----	----

Terminal No.	Color of Wire	Signal Name [Specification]
72	LG/B	-
73	LG/R	-

74	B/W	-
77	R/W	-
78	LG/Y	-

Connector No.	B575
Connector Name	SEATBACK HEATER
Connector Type	NSDZFW-CS



78	77
----	----

Terminal No.	Color of Wire	Signal Name [Specification]
77	R/W	-
78	LG/Y	-

CONNECTOR INFORMATION

< WIRING DIAGRAM >

D Door Harness

INFOID:000000008131346

DOOR HARNESS

Connector No.	D1
Connector Name	WIRE TO WIRE
Connector Type	TH4JFW-CS15

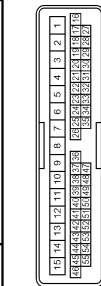

Terminal No.	Color of Wire	Signal Name [Specification]
5	B	-
6	L	-
7	R	-
8	GR	-
9	G	-
10	LG	-
11	P	-
12	LG	-
13	B/W	-
14	Y	-
15	O	-
16	R	-
17	Y	-
18	BR	-
19	W	-
20	O	-
21	GR	-
22	G	-
23	LG	-
24	B	-
27	V	-
28	W	-
29	GR	-
30	G	-
31	Y	-
32	O	-
33	BR	-
34	L	-
35	P	-
36	V	-
37	GR	-
38	O	-
39	W	-
40	R	-
41	SHIELD	-
42	L	-
43	P	-
44	V	-

45	LG	-
46	BR	-
47	L	-
48	Y	-
49	P	-
50	B/W	-
51	G	-
52	Y	-
53	B/W	-
54	W	-
55	W	-

Connector No.	D2
Connector Name	TWEETER LH
Connector Type	TK02MBR-P



Terminal No.	Color of Wire	Signal Name [Specification]
1	G	-
2	GR	-

Connector No.	D3
Connector Name	DOOR MIRROR (DRIVER SIDE)
Connector Type	TH24MW-NH

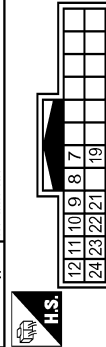

Terminal No.	Color of Wire	Signal Name [Specification]
7	P	-
8	R	-
9	V	-
10	G	-
11	GR	-
12	O	-
19	B	-

21	BR	-
22	R	-
23	W	-
24	Y	-

Connector No.	D4
Connector Name	FRONT DOOR SQUAWKER LH
Connector Type	TK02FER

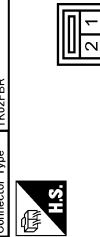

Terminal No.	Color of Wire	Signal Name [Specification]
1	G	-
2	GR	-

Connector No.	D5
Connector Name	SEAT MEMORY SWITCH
Connector Type	TH18FW-NH

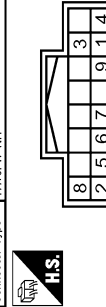

Terminal No.	Color of Wire	Signal Name [Specification]
1	R	-
2	V	-
3	W	-
4	B	-
5	LG	-
6	GR	-
7	O	-
8	Y	-
9	B/W	-

Connector No.	D6
Connector Name	FRONT DOOR SPEAKER LH
Connector Type	NS02FW-CS

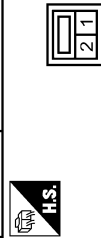

Terminal No.	Color of Wire	Signal Name [Specification]
1	G	-
2	GR	-

Connector No.	D7
Connector Name	FRONT SPEAKER (R/L) SPEAK INFORMATION PEACOCK LH
Connector Type	TH03MF-NH

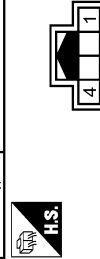

Terminal No.	Color of Wire	Signal Name [Specification]
1	L	SIGNAL
4	P	EARTH

A
B
C
D
E
F
G
H
I
J
K
L
PG
N
O
P

CONNECTOR INFORMATION

< WIRING DIAGRAM >

DOOR HARNESS

Connector No.	D8
Connector Name	WIRE TO WIRE
Connector Type	TK02FW-NH



Terminal No.	Color of Wire	Signal Name [Specification]
4	P	-
7	Y	-
8	V	-
9	GR	-
10	G	-
11	W	-
12	O	-
13	O	-
14	W	-
15	R	-
16	G	-
19	BR	-
20	SB	-
21	R	-
23	B	-
24	SB	-

Connector No.	D9
Connector Name	WIRE TO WIRE
Connector Type	NS02FW-CS



Terminal No.	Color of Wire	Signal Name [Specification]
2	LG	-
3	O	-
4	B/W	-
5	L	-
6	G	-
7	Y	-

8	B	-
---	---	---

Connector No.	D10
Connector Name	FRONT POWER WINDOW MOTOR (DRIVER SIDE)
Connector Type	NS02FW-CS



Terminal No.	Color of Wire	Signal Name [Specification]
1	G	-
2	L	-
3	O	-
4	B	-
5	P	-
6	LG	-

Connector No.	D11
Connector Name	FRONT DOOR WOOFER LH
Connector Type	NS02FW-CS



Terminal No.	Color of Wire	Signal Name [Specification]
1	R	-
2	L	-

Connector No.	D12
Connector Name	STEP LAMP (DRIVER SIDE)
Connector Type	TK02FW



Terminal No.	Color of Wire	Signal Name [Specification]
1	BR	-
2	LG	-

Connector No.	D13
Connector Name	FRONT DOOR SATELLITE SENSOR LH
Connector Type	TK02FY-IV-EX-LC



Terminal No.	Color of Wire	Signal Name [Specification]
1	P	-
2	L	-

Connector No.	D14
Connector Name	OUTSIDE KEY ANTENNA (DRIVER SIDE)
Connector Type	TK02MGY



Terminal No.	Color of Wire	Signal Name [Specification]
1	Y	ANT+
2	L	ANT-

Connector No.	D15
Connector Name	FRONT DOOR LOCK ASSEMBLY (DRIVER SIDE)
Connector Type	TK02FGY-RS



Terminal No.	Color of Wire	Signal Name [Specification]
1	P	-
2	LG	-
3	W	-
4	B	-
5	R	-
6	G	-

Connector No.	D16
Connector Name	FRONT DOOR SQUAWKER LH
Connector Type	TK02FBR



Terminal No.	Color of Wire	Signal Name [Specification]
1	G	-
2	GR	-

JRMWC9544GB

CONNECTOR INFORMATION

< WIRING DIAGRAM >

DOOR HARNESS

Connector No.	D17
Connector Name	FRONT OUTSIDE HANDLE ASSEMBLY LH
Connector Type	SA20BFW

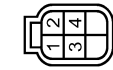

Terminal No.	Color of Wire	Signal Name [Specification]
1	G	-
2	B	-
3	V	-
4	B/W	-

Connector No.	D18
Connector Name	WIRE TO WIRE
Connector Type	TH24MW-NH



Terminal No.	Color of Wire	Signal Name [Specification]
4	P	-
7	V/W	-
8	V	-
9	V/B	-
10	V/W	-
11	V/W	-
12	O	-
13	LG	-
14	-	-
15	R	-
16	G	-
19	V	-
20	SB	-
21	R	-
23	LG	-
24	SB	-

Connector No.	D19
Connector Name	WIRE TO WIRE
Connector Type	NS16MW-CS



Terminal No.	Color of Wire	Signal Name [Specification]
2	LG	-
3	O	-
4	B	-
5	L	-
6	G	-
7	Y	-
8	B	-

Connector No.	D22
Connector Name	POWER WINDOW MAIN SWITCH
Connector Type	NS16FW-CS

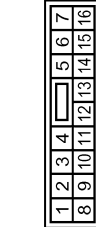

Terminal No.	Color of Wire	Signal Name [Specification]
3	B	ENCODER +
4	Y	ENCODER +
5	G	MOTOR DN DR
6	L	MOTOR UP DR
7	B	GND
9	O	IGN
10	LG	ENCODER GND
11	P	ENCODER SIG1
12	LG	ENCODER SIG2
13	-	COM
15	R	LOCK SW
16	G	UNLOCK SW

Connector No.	D23
Connector Name	POWER WINDOW MAIN SWITCH
Connector Type	TH12FW-CS

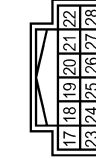

Terminal No.	Color of Wire	Signal Name [Specification]
17	SB	L OPEN
18	LG	R OPEN
20	R	L CLOSE
21	SB	R CLOSE
22	V	ACC
23	O	+SELECT L
24	V/W	+MIRROR SW L
25	V/W	+MIRROR SW DOWN
26	V/B	+MIRROR SW UP
27	V	+MIRROR SW R
28	V/W	+SELECT R

Connector No.	D31
Connector Name	WIRE TO WIRE
Connector Type	TH40FW-CS15

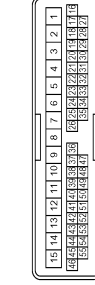

Terminal No.	Color of Wire	Signal Name [Specification]
2	B	-
3	B/W	-
5	GR	-
9	V	-
10	R	-
11	L	-
12	Y	-
13	BR	-
14	G	-
15	SB	-
16	G	-

17	P	-
18	BR	-
19	GR	-
20	V	-
21	LG	-
22	SB	-
23	G	-
24	Y	-
25	BR	-
26	L	-
32	L/O	-
33	W/L	-
34	SHIELD	-
35	W	-
36	L	-
37	P	-
38	SB	-
39	O	-
44	SB	-
45	R	-
46	B/W	-

Connector No.	D32
Connector Name	TWEETER RH
Connector Type	TK02MR-P



Terminal No.	Color of Wire	Signal Name [Specification]
1	BR	-
2	Y	-

JRMWC9545GB

A
B
C
D
E
F
G
H
I
J
K
L
PG
N
O
P

CONNECTOR INFORMATION

< WIRING DIAGRAM >

DOOR HARNESS

Connector No.	D33
Connector Name	DOOR MIRROR (PASSENGER SIDE)
Connector Type	TH2AMW-NH

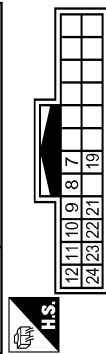

Terminal No.	Color of Wire	Signal Name [Specification]
7	W	-
8	SB	-
9	O	-
10	Y	-
11	L	-
12	BR	-
19	B	-
21	BR	-
22	G	-
23	GR	-
24	P	-

Connector No.	D34
Connector Name	FRONT DOOR SQUAWKER RH
Connector Type	TK02EB

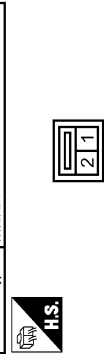

Terminal No.	Color of Wire	Signal Name [Specification]
1	BR	-
2	Y	-

Connector No.	D38
Connector Name	FRONT DOOR SPEAKER RH
Connector Type	NS02FH-CS

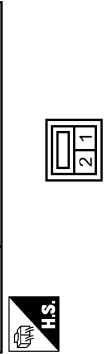

Terminal No.	Color of Wire	Signal Name [Specification]
1	BR	-
2	Y	-

Connector No.	D37
Connector Name	FRONT SPEAKER (REAR SPEAKERS) (PASSENGER SIDE)
Connector Type	TH0AMW-NH

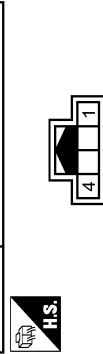

Terminal No.	Color of Wire	Signal Name [Specification]
1	P	SIGNAL
4	L	EARTH

Connector No.	D38
Connector Name	WIRE TO WIRE
Connector Type	NS08FW-CS

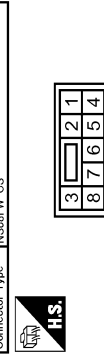

Terminal No.	Color of Wire	Signal Name [Specification]
1	G	-
3	O	-
4	B	-
5	P	-
6	LG	-

4	V	-
5	B	-
6	B/W	-
7	LG	-
8	GR	-

Connector No.	D39
Connector Name	WIRE TO WIRE
Connector Type	TH08FW-NH

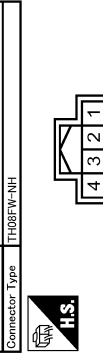

Terminal No.	Color of Wire	Signal Name [Specification]
5	O	-
8	P	-

Connector No.	D40
Connector Name	FRONT POWER WINDOW MOTOR (PASSENGER SIDE)
Connector Type	NS08FW-CS

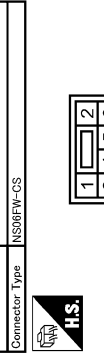

Terminal No.	Color of Wire	Signal Name [Specification]
1	G	-
2	L	-
3	O	-
4	B	-
5	P	-
6	LG	-

Connector No.	D41
Connector Name	FRONT DOOR WOOFER RH
Connector Type	NS02FW-CS

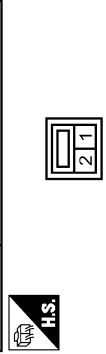

Terminal No.	Color of Wire	Signal Name [Specification]
1	L	-
2	R	-

Connector No.	D42
Connector Name	STEP LAMP (PASSENGER SIDE)
Connector Type	TE02FW

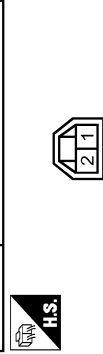

Terminal No.	Color of Wire	Signal Name [Specification]
1	G	-
2	SB	-

Connector No.	D43
Connector Name	FRONT DOOR SATELLITE SENSOR RH
Connector Type	HK02FY-1V-EX-LG



Terminal No.	Color of Wire	Signal Name [Specification]
1	L/O	-
2	W/L	-

JRMWC9546GB

CONNECTOR INFORMATION

< WIRING DIAGRAM >

DOOR HARNESS

Connector No.	D44
Connector Name	OUTSIDE KEY ANTENNA (PASSENGER SIDE)
Connector Type	PK02MGY



Terminal No.	Color of Wire	Signal Name [Specification]
1	LG	ANT+
2	V	ANT-

Connector No.	D45
Connector Name	FRONT DOOR LOCK ASSEMBLY (PASSENGER SIDE)
Connector Type	EM0FCY-RS



Terminal No.	Color of Wire	Signal Name [Specification]
1	G	-
2	SB	-

Connector No.	D46
Connector Name	FRONT DOOR SQUAWKER RH
Connector Type	TK02BR



Terminal No.	Color of Wire	Signal Name [Specification]
1	BR	-
2	Y	-

Connector No.	D47
Connector Name	FRONT OUTSIDE HANDLE ASSEMBLY RH
Connector Type	SAZ06FW



Terminal No.	Color of Wire	Signal Name [Specification]
1	SB	-
2	B	-
3	R	-
4	B/W	-

Connector No.	D48
Connector Name	WIRE TO WIRE
Connector Type	NS0BMW-CS



Terminal No.	Color of Wire	Signal Name [Specification]
1	-	-
3	-	-
4	-	-
5	-	-
6	-	-
7	-	-
8	-	-

Connector No.	D49
Connector Name	WIRE TO WIRE
Connector Type	TF06MW-NH



Terminal No.	Color of Wire	Signal Name [Specification]
5	-	-
8	-	-

Connector No.	D50
Connector Name	FRONT POWER WINDOW SWITCH (PASSENGER SIDE)
Connector Type	NS0PFP-CS

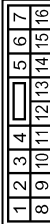

Terminal No.	Color of Wire	Signal Name [Specification]
3	-	ENCODER GND
4	-	ENCODER +
8	-	MOTOR UP AS
9	-	MOTOR DN AS
10	-	+B
11	-	GND
12	-	ENCODER SIG1
15	-	ENCODER SIG2
16	-	COM

Connector No.	D51
Connector Name	WIRE TO WIRE
Connector Type	NH10MW-SS10

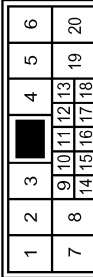

Terminal No.	Color of Wire	Signal Name [Specification]
1	BR	-
2	V	-
3	R	-
4	L	-
7	B	-
8	P	-
9	W	-
10	V	-
11	L	-
12	LG	-
13	B	-

Connector No.	D52
Connector Name	REAR POWER WINDOW MOTOR LH
Connector Type	RS06FG-DGY



Terminal No.	Color of Wire	Signal Name [Specification]
1	P	-
2	V	-
3	G	-
4	BR	-
5	W	-
6	O	-

JRMWC9547GB

A
B
C
D
E
F
G
H
I
J
K
L
PG
N
O
P

CONNECTOR INFORMATION

< WIRING DIAGRAM >

DOOR HARNESS

Connector No.	D55
Connector Name	REAR DOOR LOCK ASSEMBLY LH
Connector Type	ES0FGY-RS



Connector No.	D56
Connector Name	REAR DOOR LOCK ASSEMBLY LH
Connector Type	ES0FGY-RS

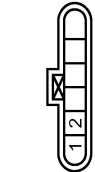

Connector No.	D58
Connector Name	ASHTRAY ILLUMINATION (REAR LH)
Connector Type	AB0FW

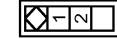

Connector No.	D72
Connector Name	REAR POWER WINDOW MOTOR RH
Connector Type	RS0BFG-DGY



Terminal No.	Color of Wire	Signal Name [Specification]
1	L	-
2	R	-

Terminal No.	Color of Wire	Signal Name [Specification]
1	V	-
2	BR	-

Terminal No.	Color of Wire	Signal Name [Specification]
1	L	-
2	B	-

Terminal No.	Color of Wire	Signal Name [Specification]
1	P	-
2	V	-
3	G	-
4	BR	-
5	W	-
6	O	-

Connector No.	D54
Connector Name	REAR POWER WINDOW SWITCH LH
Connector Type	NS10FW-CS

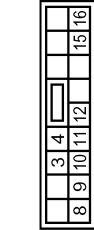

Connector No.	D56
Connector Name	REAR DOOR SPEAKER LH
Connector Type	NS02FBR-CS



Connector No.	D71
Connector Name	WIRE TO WIRE
Connector Type	NH10MH-CS10

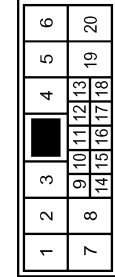

Terminal No.	Color of Wire	Signal Name [Specification]
3	BR	-
4	V	-
8	P	-
9	G	-
10	P	-
11	B	-
12	W	-
15	O	-
16	LG	-

Terminal No.	Color of Wire	Signal Name [Specification]
1	L	-
2	R	-

Terminal No.	Color of Wire	Signal Name [Specification]
1	BR	-
2	V	-
3	R	-
4	L	-
7	B	-
8	P	-
9	W	-
10	Y	-
11	L	-
12	LG	-
13	B	-

Connector No.	D57
Connector Name	STEP LAMP (REAR LH)
Connector Type	IB02FW



Connector No.	D73
Connector Name	REAR DOOR SPEAKER RH
Connector Type	NS02FW-CS



Terminal No.	Color of Wire	Signal Name [Specification]
1	L	-
2	R	-



JRMWC9548GB

CONNECTOR INFORMATION

< WIRING DIAGRAM >

A
B
C
D
E
F
G
H
I
J
K
L
N
O
P

DOOR HARNESS

Connector No.	D74
Connector Name	REAR POWER WINDOW SWITCH RH
Connector Type	MS18FW-CS



Terminal No.	Color of Wire	Signal Name [Specification]
3	BR	-
4	V	-
8	P	-
9	G	-
10	P	-
11	B	-
12	W	-
15	O	-
16	LG	-

Connector No.	D75
Connector Name	REAR DOOR LOCK ASSEMBLY RH
Connector Type	E06FGY-FS



Terminal No.	Color of Wire	Signal Name [Specification]
1	BR	-
2	V	-

Connector No.	D76
Connector Name	REAR DOOR SPEAKER RH
Connector Type	MS2FBR-CS



Terminal No.	Color of Wire	Signal Name [Specification]
1	L	-
2	R	-

Connector No.	D77
Connector Name	STEP LAMP (REAR RH)
Connector Type	TB02FN



Terminal No.	Color of Wire	Signal Name [Specification]
1	W	-
2	V	-

Connector No.	D78
Connector Name	ASHTRAY ILLUMINATION (REAR RH)
Connector Type	A03FW

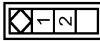

Terminal No.	Color of Wire	Signal Name [Specification]
1	L	-
2	B	-

JRMWC9549GB

CONNECTOR INFORMATION

< WIRING DIAGRAM >

E Engine Room Harness

INFOID:000000008131347

ENGINE ROOM HARNESS

Connector No.	E1
Connector Name	BATTERY TERMINAL WITH FUSELE LINK
Connector Type	LO2FB-MC



Terminal No.	Color of Wire	Signal Name [Specification]
1	R	-
2	W	-

Connector No.	E2
Connector Name	BATTERY TERMINAL WITH FUSELE LINK
Connector Type	LO2FY-MC



Terminal No.	Color of Wire	Signal Name [Specification]
3	R	-
4	L	-

Connector No.	E4
Connector Name	IPDM E/R INTELLIGENT POWER DISTRIBUTION MODULE (ENGINE ROOM)
Connector Type	LO2FB-MC



Terminal No.	Color of Wire	Signal Name [Specification]
1	W	F/L MAIN
2	L	F/L USM

Connector No.	E5
Connector Name	IPDM E/R INTELLIGENT POWER DISTRIBUTION MODULE (ENGINE ROOM)
Connector Type	TH20FW-CS12-M4-1V



Terminal No.	Color of Wire	Signal Name [Specification]
4	W	ENG SOL
5	P	IGN COIL
6	SB	ECM.VB [With VK engine]
6	R	ECM.VB [With VQ engine]
7	R	ETC [With VK engine]
7	Y	ETC [With VQ engine]
8	L/Y	A/C COMP [With VK engine]
8	P	A/C COMP [With VQ engine]
10	V	ECM.BAT
11	B	P-GND
12	G	ABS ECU
13	W	FUEL PUMP [With VK engine]
13	GR	FUEL PUMP [With VQ engine]
16	V	WIPER.AUTOSTOP
18	Y	IGN SIGNAL
22	BR	ALI-C
23	SB	DTRL RL.V [With VK engine]
23	P	DTRL RL.L [With VQ engine]
24	O	HOOD SW
25	LG	SUB ECU
30	BR	PUSH START SW
31	BR	NP SW [With VK engine]
31	LG	NP SW [With VQ engine]
36	GR	F/L IGN SW

Connector No.	E6
Connector Name	IPDM E/R INTELLIGENT POWER DISTRIBUTION MODULE (ENGINE ROOM)
Connector Type	TH88FW-NH



Terminal No.	Color of Wire	Signal Name [Specification]
39	P	CAN-L
40	L	CAN-H
41	B	S-GND
42	V	MOTOR.FAN.RLY.CONT [With VK engine]
42	Y	MOTOR.FAN.RLY.CONT [With VQ engine]
43	SB	DETENT SW
44	GR	HORN.RLY [With VK engine]
44	LG	HORN.RLY [With VQ engine]
45	G	HORN SW
46	BR	START CONT

Connector No.	E7
Connector Name	IPDM E/R INTELLIGENT POWER DISTRIBUTION MODULE (ENGINE ROOM)
Connector Type	TH20FW-CS12-M4



Terminal No.	Color of Wire	Signal Name [Specification]
48	W	DTRL DEIGER
51	O	WASH.MTR
52	G	INJECTOR #1
53	L	FR.WIPER.HI
54	P	FR.WIPER.LO
55	R	TAIL/LLUM
56	GR	O2 SENS #1
57	V	O2 SENS #2
58	BR	AT ECU
70	LG	SSOFF
71	O	MOT.RLY
73	G	START IG-E/R
74	R	START IG-ECU
75	Y	OIL PRESSURE SW
77	B	FRR
80	W	STARTER MOTOR

Connector No.	E8
Connector Name	IPDM E/R INTELLIGENT POWER DISTRIBUTION MODULE (ENGINE ROOM)
Connector Type	NS38FW-CS

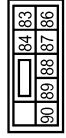

Terminal No.	Color of Wire	Signal Name [Specification]
83	R	HEAD LAMP LO RH
84	W	HEAD LAMP LO LH
86	W/R	FR.FOG.LAMP.RH [With VK engine]
86	G	FR.FOG.LAMP.RH [With VQ engine]
87	L/Y	FR.FOG.LAMP.LH [With VK engine]
87	L	FR.FOG.LAMP.LH [With VQ engine]
88	O	FR.WIPER.B
89	Y	HEAD LAMP HI RH
90	P	HEAD LAMP HI LH

Connector No.	E9
Connector Name	IPDM E/R INTELLIGENT POWER DISTRIBUTION MODULE (ENGINE ROOM)
Connector Type	TH16FW-NH

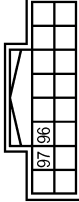

Terminal No.	Color of Wire	Signal Name [Specification]
96	R	WIPER REV RLY
97	V	MOTOR.FAN.PWM

CONNECTOR INFORMATION

< WIRING DIAGRAM >

ENGINE ROOM HARNESS

Connector No.	E11
Connector Name	HORN RELAY
Connector Type	24381 796DA

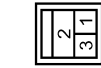

Terminal No.	Color of Wire	Signal Name [Specification]
1	LG	-
2	W	-
3	G	-

Connector No.	E14
Connector Name	BATTERY TERMINAL WITH FUSELE LINK
Connector Type	-



Terminal No.	Color of Wire	Signal Name [Specification]
5	L	-

Connector No.	E15
Connector Name	VVEL CONTROL MODULE
Connector Type	RH18FB-AJ28-LH

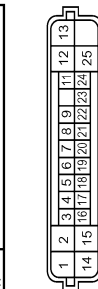

Terminal No.	Color of Wire	Signal Name [Specification]
1	W	VMOT-B2
2	L/B	MOTOR1-B2

3	Y	VEL/S1-B1 [With VK engine]
3	B	VEL/S1-B1 [With VQ engine]
4	W	SENSOR BATTERY LEVEL CONTROL, BANK POSITION SENSOR (BANK 2)
5	L	VEL/S1-B2 [With VK engine]
5	W	VEL/S1-B2 [With VQ engine]
6	B	SENSOR BATTERY LEVEL CONTROL, BANK POSITION SENSOR (BANK 2)
7	W	AVCC3 [With VK engine]
7	Y	AVCC3 [With VQ engine]
8	R	POWER SUPPLY FOR VVEL CONTROL MODULE
9	B	AVCC1 [With VK engine]
9	L	AVCC1 [With VQ engine]
11	GR	ENGINE COMMUNICATION LINE
12	L/B	VVEL ACTUATOR MOTOR (HIGH LIFT) (BANK 1)
13	W	VMOT-B1
14	B/R	VVEL CONTROL MODULE GROUND
15	L/W	MOTOR2-B2
16	G	VEL/S2-B1 [With VK engine]
16	R	VEL/S2-B1 [With VQ engine]
17	Y	AGND2 [With VK engine]
17	G	AGND2 [With VQ engine]
18	R	VEL/S2-B2 [With VK engine]
18	G	VEL/S2-B2 [With VQ engine]
19	L	AGND4 [With VK engine]
19	R	AGND4 [With VQ engine]
20	R	AVCC4 [With VK engine]
20	L	AVCC4 [With VQ engine]
21	V	VVEL ACTUATOR MOTOR RELAY ABORT SIGNAL
22	G	AVCC2 [With VK engine]
22	Y	AVCC2 [With VQ engine]
23	P	VVEL ACTUATOR MOTOR RELAY
24	L	CAN L
25	L/W	MOTOR2-B1

Connector No.	E16
Connector Name	VVEL ACTUATOR MOTOR RELAY
Connector Type	24347 9F500



Terminal No.	Color of Wire	Signal Name [Specification]
1	B	-
2	P	-
3	W	-
5	B	-

Connector No.	E17
Connector Name	COOLING FAN RELAY 1
Connector Type	24347 9F500



Terminal No.	Color of Wire	Signal Name [Specification]
1	V	-
2	G	-
3	L	-
5	R	-

Connector No.	E18
Connector Name	VEHICLE SECURITY HORN RELAY
Connector Type	M03FW-R-LC

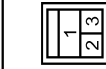

Terminal No.	Color of Wire	Signal Name [Specification]
1	W	-
2	R	-
3	G	-

Connector No.	E19
Connector Name	COOLING FAN RELAY 2
Connector Type	24347 9F500



JRMWC9551GB

A
B
C
D
E
F
G
H
I
J
K
L
M
N
O
P

PG

CONNECTOR INFORMATION

< WIRING DIAGRAM >

ENGINE ROOM HARNESS

Connector No.	E20
Connector Name	WIRE TO WIRE
Connector Type	SAA30MB-RSS-S1ZB

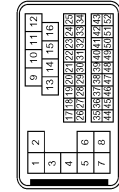

Terminal No.	Color of Wire	Signal Name [Specification]
1	L/W	-
2	SHIELD	-
3	L/B	-
4	SHIELD	-
5	L/W	-
6	W	-
7	L/B	-
8	P	-
9	G	-
10	G	-
11	W	- [With VK engine]
11	Y	- [With VQ engine]
12	V	-
13	L	-
14	LG	- [With VK engine]
14	V	- [With VQ engine]
15	SB	-
16	GR	-
18	W	-
20	BR	-
21	G	-
22	O	-
23	L	-
24	GR	-
25	Y	-
26	V	-
28	Y	-
30	B	-
31	LG	-
32	W	-
33	BR	-
34	O	-
37	SHIELD	-
38	G	-
39	Y	-
40	R	-
41	W	-
42	L	-
43	B	-

46	SHIELD	-
47	R	-
48	L	-
48	G	-
50	B	-
51	Y	-
52	W	-

Connector No.	E21
Connector Name	BATTERY CURRENT SENSOR
Connector Type	SAZ0MFGY



Terminal No.	Color of Wire	Signal Name [Specification]
1	Y	-
2	BR	-
3	O	-
4	G	-

Connector No.	E23
Connector Name	GRASH ZONE SENSOR
Connector Type	HK02FY-IV-EX-LC



Terminal No.	Color of Wire	Signal Name [Specification]
1	W/L	-
2	L/O	-

Connector No.	E24
Connector Name	FRONT COMBINATION LAMP RH
Connector Type	RSS0FB-PR



Terminal No.	Color of Wire	Signal Name [Specification]
1	O	-
2	Y	-
3	V	-
4	R	-
5	B/W	-
6	B/W	-

Connector No.	E26
Connector Name	HEADLAMP AIMING MOTOR RH
Connector Type	HS00FGY



Terminal No.	Color of Wire	Signal Name [Specification]
1	G	AIMER_VCC
2	B/W	AIMER_GND
3	W	AIMER_SIG

Connector No.	E27
Connector Name	FRONT WHEEL SENSOR RH
Connector Type	RR02FB



Terminal No.	Color of Wire	Signal Name [Specification]
1	BR	-
1	W	- [Except for Federal with ZWHI sport advanced technology]
2	B	- [For Federal with ZWHI sport advanced technology]

Connector No.	E28
Connector Name	TIRE PRESSURE RECEIVER FRONT RH
Connector Type	RR04FB

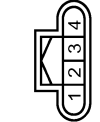

Terminal No.	Color of Wire	Signal Name [Specification]
1	W	VCC
2	G	RSSI
3	GR	SIG
4	R	GND

JRMWC9552.GB

CONNECTOR INFORMATION

< WIRING DIAGRAM >

ENGINE ROOM HARNESS

Connector No.	E29
Connector Name	HEADLAMP SWIVEL ACTUATOR RH
Connector Type	PS08FGY-FR

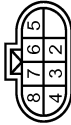

Terminal No.	Color of Wire	Signal Name [Specification]
2	O	SENS GND
3	B	MOTOR1 B-
4	R	MOTOR2 A-
5	Y	SENS SIG
6	BR	SENS VCC
7	W	MOTOR1 B+
8	G	MOTOR2 A+

Connector No.	E30
Connector Name	HOOD SWITCH
Connector Type	RH02FB



Terminal No.	Color of Wire	Signal Name [Specification]
1	B/W	
2	O	

Connector No.	E31
Connector Name	WASHER PUMP
Connector Type	E02FGY-FS



Terminal No.	Color of Wire	Signal Name [Specification]
1	O	
2	W	

Connector No.	E32
Connector Name	WASHER LEVEL SWITCH
Connector Type	Z02FB



Terminal No.	Color of Wire	Signal Name [Specification]
1	GR	
2	B/W	

Connector No.	E34
Connector Name	FRONT FOG LAMP RH
Connector Type	FH202FB



Terminal No.	Color of Wire	Signal Name [Specification]
1	G	
2	B/W	

Connector No.	E35
Connector Name	INJECTOR RELAY 1
Connector Type	MS02FL-M2-LC



Terminal No.	Color of Wire	Signal Name [Specification]
1	B	
2	R	
3	W	
4	W	
5	W	

Connector No.	E36
Connector Name	INJECTOR RELAY 2
Connector Type	MS02FL-M2-LC



Terminal No.	Color of Wire	Signal Name [Specification]
1	B/W	
2	P	
3	P	
5	V	

Connector No.	E37
Connector Name	COOLING FAN CONTROL MODULE I
Connector Type	ISJ20FGY-SNZ2



Terminal No.	Color of Wire	Signal Name [Specification]
1	B/W	
2	V	
3	R	

Connector No.	E38
Connector Name	VACUUM SENSOR
Connector Type	YE208FDGY



Terminal No.	Color of Wire	Signal Name [Specification]
1	LG	OUTPUT 2 (SHIELD) (Shield for Fuelrail with 2WHL sport advanced technology)
1	P	OUTPUT 3 (SHIELD) (Shield for Fuelrail with 2WHL sport advanced technology)
2	SHIELD	GND
3	V	VCC (16V) (Power for Fuelrail with 2WHL sport advanced technology)
3	L	VCC (16V) (Power for Fuelrail with 2WHL sport advanced technology)

Connector No.	E39
Connector Name	COOLING FAN CONTROL MODULE 2
Connector Type	ISJ20FGY-SNZ2



Terminal No.	Color of Wire	Signal Name [Specification]
1	B/W	
2	V	
3	L	

A
B
C
D
E
F
G
H
I
J
K
L
N
O
P

PG

JRMWC9553GB

CONNECTOR INFORMATION

< WIRING DIAGRAM >

ENGINE ROOM HARNESS

Connector No.	E41
Connector Name	AIR ACTUATOR AND ELECTRICAL UNIT (CONTROL UNIT)
Connector Type	SAE30FB-SJZ4-U

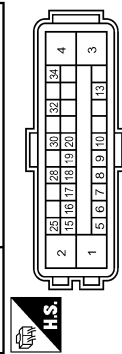

Terminal No.	Color of Wire	Signal Name [Specification]
1	B/W	EDUCED [Event for Federal with 2001 sport advanced technology]
2	B	EDUOND [For Federal with 2001 sport advanced technology]
1	B	MOTOR(GND)
3	Y	SOLENOID(POWER)
4	G	MOTOR(POWER)
5	SB	STOP LAMP SW
6	Y	CANM2(-)
7	W	IN-12 (RESERVA) [Event for Federal with 2001 sport advanced technology]
7	GR	IN-12 (RESERVA) [For Federal with 2001 sport advanced technology]
8	G	IN-12 (RESERVA) [Event for Federal with 2001 sport advanced technology]
8	B	IN-12 (RESERVA) [For Federal with 2001 sport advanced technology]
9	BR	IN-12 (RESERVA) [Event for Federal with 2001 sport advanced technology]
9	W	IN-12 (RESERVA) [For Federal with 2001 sport advanced technology]
10	B	FR-RH SEN(POWER)
13	LG	VAG SENS(DUAL) [Event for Federal with 2001 sport advanced technology]
13	P	VAG SENS(DUAL) [For Federal with 2001 sport advanced technology]
15	P	CAN-L
16	B	CANM2(+)
17	Y	IN-12 (RESERVA) [Event for Federal with 2001 sport advanced technology]
17	LG	IN-12 (RESERVA) [For Federal with 2001 sport advanced technology]
18	BR	FR-RH SEN(POWER)
19	SB	IN-12 (RESERVA) [Event for Federal with 2001 sport advanced technology]
19	Y	IN-12 (RESERVA) [For Federal with 2001 sport advanced technology]
20	R	IN-12 (RESERVA) [Event for Federal with 2001 sport advanced technology]
20	R	IN-12 (RESERVA) [For Federal with 2001 sport advanced technology]
26	L	CAN-H
28	V	VAG SENS(POWER) [Event for Federal with 2001 sport advanced technology]
28	L	VAG SENS(POWER) [For Federal with 2001 sport advanced technology]
30	R	VDC OFF SW
32	SHIELD	VAG SEN(GND)
34	G	IGN(POWER)

Connector No.	E42
Connector Name	FRONT WIPER MOTOR
Connector Type	RS08FGY-PR

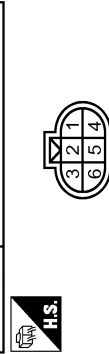

Terminal No.	Color of Wire	Signal Name [Specification]
1	SB	-
2	L	-
3	P	-
4	O	-
5	V	-
6	B	-

Connector No.	E44
Connector Name	WIPER REVERSE RELAY
Connector Type	MS08FB-M2-LC

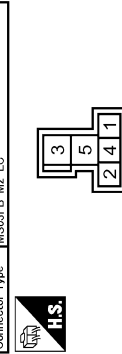

Terminal No.	Color of Wire	Signal Name [Specification]
1	G	-
2	R	-
3	SB	-
4	B	-
5	O	-

Connector No.	E45
Connector Name	DAYTIME RUNNING LIGHT RELAY
Connector Type	MS02FL-M2-LC

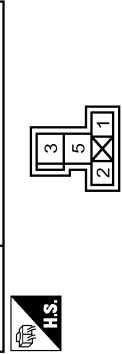

Terminal No.	Color of Wire	Signal Name [Specification]
1	SB	-
2	W	-
3	O	-
5	W	-

Connector No.	E47
Connector Name	BRAKE FLUID LEVEL SWITCH
Connector Type	YV02FGY

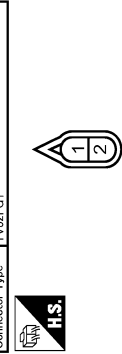

Terminal No.	Color of Wire	Signal Name [Specification]
1	SB	-
2	B	-

Connector No.	E52
Connector Name	SHIFT LOCK RELAY
Connector Type	MS02FL-M2-LC

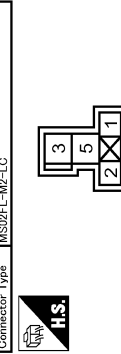

Terminal No.	Color of Wire	Signal Name [Specification]
1	SB	-
2	B	-

Terminal No.	1	B
Terminal No.	2	V
Terminal No.	3	Y
Terminal No.	5	G

Connector No.	E54
Connector Name	FRONT COMBINATION LAMP LH
Connector Type	RS08FB-PR

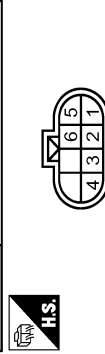

Terminal No.	Color of Wire	Signal Name [Specification]
1	O	-
2	P	-
3	G	-
4	W	-
5	B/Y	-
6	B/Y	-

Connector No.	E56
Connector Name	HEADLAMP AMING MOTOR LH
Connector Type	HS03FGY

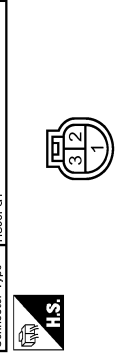

Terminal No.	Color of Wire	Signal Name [Specification]
1	G	AIMER VCC
2	B/Y	AIMER GND
3	GR	AIMER SIG

CONNECTOR INFORMATION

< WIRING DIAGRAM >

ENGINE ROOM HARNESS

Connector No.	E57
Connector Name	INTELLIGENT KEY MARKING BUZZER ENGINE ROOM
Connector Type	PK03FBR



Terminal No.	Color of Wire	Signal Name [Specification]
1	Y	(+)+BAT
3	V	BUZZER SIGNAL

Connector No.	E58
Connector Name	TIRE PRESSURE RECEIVER FRONT LH
Connector Type	RH04FB



Terminal No.	Color of Wire	Signal Name [Specification]
1	SB	VCC
2	O	RSSI
3	V	SIG
4	B	GND

Connector No.	E59
Connector Name	HEADLAMP SWIVEL ACTUATOR LH
Connector Type	RS08FGY-PR



Terminal No.	Color of Wire	Signal Name [Specification]
--------------	---------------	-----------------------------

2	BR	SENS GND
3	B	MOTOR1 B-
4	R	MOTOR2 A-
5	P	SENS SIG
6	LG	SENS VCC
7	W	MOTOR1 B+
8	G	MOTOR2 A+

Connector No.	E60
Connector Name	FRONT WHEEL SENSOR LH
Connector Type	RH02FB



Terminal No.	Color of Wire	Signal Name [Specification]
1	SB	[Except for Federal with ZWH1 sport advanced technology]
1	Y	[For Federal with ZWH1 sport advanced technology]
2	O	[Except for Federal with ZWH1 sport advanced technology]
2	R	[For Federal with ZWH1 sport advanced technology]

Connector No.	E61
Connector Name	VEHICLE SECURITY HORN
Connector Type	IP01FB-A



Terminal No.	Color of Wire	Signal Name [Specification]
1	R	-

Connector No.	E62
Connector Name	VEHICLE SECURITY HORN
Connector Type	IP01FB-A



Terminal No.	Color of Wire	Signal Name [Specification]
2	B/Y	-

Connector No.	E64
Connector Name	FRONT FOG LAMP LH
Connector Type	FH0202FB



Terminal No.	Color of Wire	Signal Name [Specification]
1	L	-
2	B/Y	-

Connector No.	E67
Connector Name	ICC SENSOR
Connector Type	RS08FEB-PR



Terminal No.	Color of Wire	Signal Name [Specification]
1	LG	IGNITION
3	L	ITS COMM-H
4	B/Y	GND

6	Y	ITS COMM-L
---	---	------------

Connector No.	E71
Connector Name	HORN (HIGH)
Connector Type	IP01FB-A



Terminal No.	Color of Wire	Signal Name [Specification]
1	G	-

Connector No.	E72
Connector Name	HORN (HIGH)
Connector Type	IP01FB-A



Terminal No.	Color of Wire	Signal Name [Specification]
2	B/Y	-

JRMWC9555GB

A
B
C
D
E
F
G
H
I
J
K
L
M
N
O
P

PG

CONNECTOR INFORMATION

< WIRING DIAGRAM >

ENGINE ROOM HARNESS

Connector No.	E/4
Connector Name	IGNMIST GAS / OUTSIDE NOXDETECTING SENSOR
Connector Type	R1D3FB



Terminal No.	Color of Wire	Signal Name [Specification]
1	G	AGS POWER
2	B/Y	AGS S GND
3	R	AGS S OUTPUT

Connector No.	E/6
Connector Name	AMBIENT SENSOR
Connector Type	RS02FB



Terminal No.	Color of Wire	Signal Name [Specification]
1	GR	-
2	SB	-

Connector No.	E/7
Connector Name	REFRIGERANT PRESSURE SENSOR
Connector Type	RQ03FB



Terminal No.	Color of Wire	Signal Name [Specification]
1	BR	-

Terminal No.	2	LG	-
Terminal No.	3	W	-

Connector No.	E/9
Connector Name	IGC BRAKE HOLD RELAY
Connector Type	MS02FL-M2-LC



Terminal No.	Color of Wire	Signal Name [Specification]
1	V	-
2	LG	-
3	V	-
5	W	-

Connector No.	E/10
Connector Name	FUSE BLOCK (J/B)
Connector Type	L01FW-MC



Terminal No.	Color of Wire	Signal Name [Specification]
1D	R	-

Connector No.	E/102
Connector Name	FUSE BLOCK (J/B)
Connector Type	M02FB-LC



Terminal No.	Color of Wire	Signal Name [Specification]
1E	GR	-

Connector No.	E/103
Connector Name	FUSE BLOCK (J/B)
Connector Type	NS10RFV-CS

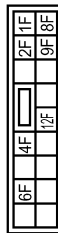

Terminal No.	Color of Wire	Signal Name [Specification]
1F	SB	-
2F	LG	-
4F	G	-
6F	O	-
8F	BR	-
9F	R	-
12F	Y	-

Connector No.	E/104
Connector Name	AFS CONTROL UNIT
Connector Type	TH40PW-NH



Terminal No.	Color of Wire	Signal Name [Specification]
1	G	IGN
2	O	PSG-R
3	GR	SW
4	BR	PSV-R
6	V	HSV-R
7	P	CAN-L
8	B	HSC-R
9	Y	PS-R
11	R	SMR-1 (-)
13	B	SMR-2 (-)
15	W	SM-L (-)
17	G	SM-L-2 (-)
19	W	AMDS-R
24	LG	PSV-L
25	B	GND
27	BR	PSG-L
28	SS	HS-R
29	P	PS-L
30	L	CAN-H
32	W	SMR-2 (-)
34	G	SMR-1 (-)
36	R	SM-L-2 (-)
38	B	SM-L-1 (-)
40	GR	AMDS-L

Connector No.	E/105
Connector Name	WIRE TO WIRE
Connector Type	MS2MW-LC



Terminal No.	Color of Wire	Signal Name [Specification]
1	GR	-
2	L	-

JRMWC9556GB

CONNECTOR INFORMATION

< WIRING DIAGRAM >

ENGINE ROOM HARNESS

Connector No.	E106
Connector Name	WIRE TO WIRE
Connector Type	TH10FW-CS16-TM4

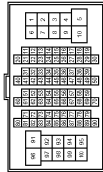

Terminal No.	Color of Wire	Signal Name [Specification]
1	P	-
2	W	-
3	SB	-
4	LG	-
5	O	-
7	GR	-
8	G	-
9	Y	-
10	BR	-
11	SB	-
12	V	-
13	GR	-
14	GR	-
15	V	-
16	Y	-
17	GR	-
18	V	-
20	BR	-
21	P	-
22	L	-
23	P	-
27	SHIELD	-
28	L/O	-
29	W/L	-
31	BR	-
32	G	-
33	O	-
34	Y	-
41	BR	-
44	W	-
45	L	-
46	GR	-
47	V	-
48	G	-
48	O	-
50	LG	-
60	W	-
60	GR	-

- [Except for Federal with 2WH sport advanced technology]
 - [For Federal with 2WH sport advanced technology]
 - [Except for Federal with 2WH sport advanced technology]
 - [For Federal with 2WH sport advanced technology]

61	G	-
61	B	-
62	Y	-
62	LG	-
63	BR	-
64	B	-
65	Y	-
66	R	-
67	SB	-
77	O	-
78	SB	-
80	G	-
81	R	-
82	SB	-
83	GR	-
84	Y	-
85	Y	-
86	L	-
87	V	-
88	BR	-
88	LG	-
89	W	-
91	W	-
92	P	-
93	LG	-
94	BR	-
95	W	-
96	R	-
97	R	-
98	Y	-
99	V	-
100	V	-

Connector No.	E107
Connector Name	PARKING BRAKE SWITCH
Connector Type	TB01FW-LC



Terminal No.	Color of Wire	Signal Name [Specification]
1	V	-

Connector No.	E108
Connector Name	WIRE TO WIRE
Connector Type	NS16MW-CS



Terminal No.	Color of Wire	Signal Name [Specification]
4	GR	-
5	W	-
6	G	-
7	R	-
13	V	-
14	SB	-
15	O	-
16	B	-

Connector No.	E109
Connector Name	ASC0 BRAKE SWITCH
Connector Type	M02FBR-LC



Terminal No.	Color of Wire	Signal Name [Specification]
1	G	-
2	P	-

Connector No.	E110
Connector Name	STOP LAMP SWITCH
Connector Type	MS4FW-LC



Terminal No.	Color of Wire	Signal Name [Specification]
1	W	-
2	V	-
3	W	- [With LCC]
3	G	- [Without LCC]
4	SB	-

Connector No.	E113
Connector Name	WIRE TO WIRE
Connector Type	NS16MW-CS

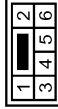

Terminal No.	Color of Wire	Signal Name [Specification]
1	SHIELD	-
3	W	-
4	R	-
5	G	-
6	B	-

JRMWC9557GB



A
B
C
D
E
F
G
H
I
J
K
L
PG
N
O
P

CONNECTOR INFORMATION

< WIRING DIAGRAM >



ENGINE ROOM HARNESS

Connector No.	E114
Connector Name	IGC BRAKE SWITCH
Connector Type	IMPZER-LC



Terminal No.	Color of Wire	Signal Name [Specification]
1	G	-
2	P	-

Connector No.	E115
Connector Name	WIRE TO WIRE
Connector Type	NS12MW-CS



Terminal No.	Color of Wire	Signal Name [Specification]
4	O	-
5	B	-
10	W	- [With VK engine]
10	P	- [With VG engine]
11	V	-
12	SB	-

Connector No.	E116
Connector Name	BRAKE PEDAL STROKE SENSOR
Connector Type	HS04FB



Terminal No.	Color of Wire	Signal Name [Specification]
1	G	OUT 1
2	R	VCC
3	B	OUT 2
4	W	GND

Connector No.	E202
Connector Name	BATTERY TERMINAL WITH FUSIBLE LINK
Connector Type	-



Terminal No.	Color of Wire	Signal Name [Specification]
6	B/GR	-

Connector No.	E203
Connector Name	ALTERNATOR
Connector Type	-



Terminal No.	Color of Wire	Signal Name [Specification]
1	B/GR	-

Connector No.	E204
Connector Name	STARTER MOTOR
Connector Type	-



Terminal No.	Color of Wire	Signal Name [Specification]
2	B/Y	-

Connector No.	E205
Connector Name	BATTERY TERMINAL WITH FUSIBLE LINK
Connector Type	-



Terminal No.	Color of Wire	Signal Name [Specification]
7	B/Y	-

Connector No.	E301
Connector Name	COOLING FAN CONTROL MODULE 1
Connector Type	6188-0259



Terminal No.	Color of Wire	Signal Name [Specification]
4	-	-
5	-	-

Connector No.	E302
Connector Name	COOLING FAN CONTROL MODULE 1
Connector Type	6188-0259

Terminal No.	Color of Wire	Signal Name [Specification]
6	-	-
7	-	-

Connector No.	E303
Connector Name	COOLING FAN CONTROL MODULE 2
Connector Type	6188-0259

Terminal No.	Color of Wire	Signal Name [Specification]
6	-	-
7	-	-

JRMWC9558GB

CONNECTOR INFORMATION

< WIRING DIAGRAM >

F Engine Control Harness

INFOID:000000008131348

ENGINE CONTROL HARNESS

Connector No.	F2
Connector Name	CRANKSHAFT POSITION SENSOR
Connector Type	RHD3FB



Terminal No.	Color of Wire	Signal Name [Specification]
1	B	- [With VK engine]
1	R	- [With VO engine]
2	R	- [With VK engine]
2	B	- [With VO engine]
3	L	-

Connector No.	F4
Connector Name	HIGH PRESSURE FUEL PUMP
Connector Type	HSDFLY-VR



Terminal No.	Color of Wire	Signal Name [Specification]
1	W	-
2	B	-

Connector No.	F5
Connector Name	CAKSHAFT POSITION SENSOR (BANK 1)
Connector Type	RHD3FB



Terminal No.	Color of Wire	Signal Name [Specification]
1	G	-
2	O	-
3	L	-

Connector No.	F6
Connector Name	FUEL RAIL PRESSURE SENSOR
Connector Type	AFZ03FB



Terminal No.	Color of Wire	Signal Name [Specification]
1	W	-
2	G	-
3	B	-

Connector No.	F7
Connector Name	EVAP CANISTER PURGE VOLUME CONTROL SOLENOID VALVE
Connector Type	ED2FL-RS-LGY



Terminal No.	Color of Wire	Signal Name [Specification]
1	R	POWER
2	GR	GND

Connector No.	F8
Connector Name	CONDENSER
Connector Type	MD2FW-LC



Terminal No.	Color of Wire	Signal Name [Specification]
1	W	-
2	B	-

Connector No.	F9
Connector Name	WIRE TO WIRE
Connector Type	RSD4FL-B



Terminal No.	Color of Wire	Signal Name [Specification]
1	W	-
2	SHIELD	-
3	GR	-
4	SHIELD	-

Connector No.	F10
Connector Name	EVAP CANISTER PURGE VOLUME CONTROL SOLENOID VALVE
Connector Type	ED2FL-RS



Terminal No.	Color of Wire	Signal Name [Specification]

1	L	POWER
2	GR	GND

Connector No.	F11
Connector Name	IGNITION COIL No. 1 (with POWER TRANSISTOR)
Connector Type	EG3FGY-RS



Terminal No.	Color of Wire	Signal Name [Specification]
1	Y	-
2	B	-
3	W/B	-

Connector No.	F12
Connector Name	IGNITION COIL No. 2 (with POWER TRANSISTOR)
Connector Type	EG3FGY-RS



Terminal No.	Color of Wire	Signal Name [Specification]
1	G	-
2	B	-
3	W	-

A
B
C
D
E
F
G
H
I
J
K
L
O
P

PG

JRMWC8559GB

CONNECTOR INFORMATION

< WIRING DIAGRAM >

ENGINE CONTROL HARNESS

Connector No.	F13
Connector Name	IGNITION COIL No. 3 (WITH POWER TRANSISTOR)
Connector Type	E03FGY-RS



Terminal No.	Color of Wire	Signal Name [Specification]
1	L	-
2	B	-
3	W	-

Connector No.	F14
Connector Name	IGNITION COIL No. 4 (WITH POWER TRANSISTOR)
Connector Type	E03FGY-RS

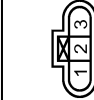

Terminal No.	Color of Wire	Signal Name [Specification]
1	GR	-
2	B	-
3	W	-

Connector No.	F15
Connector Name	IGNITION COIL No. 5 (WITH POWER TRANSISTOR)
Connector Type	E03FGY-RS

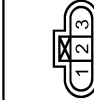

Terminal No.	Color of Wire	Signal Name [Specification]
1	GR	-
2	B	-
3	W	-

1	LG
2	B
3	W

Connector No.	F16
Connector Name	IGNITION COIL No. 6 (WITH POWER TRANSISTOR)
Connector Type	E03FGY-RS

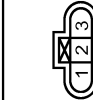

Terminal No.	Color of Wire	Signal Name [Specification]
1	V	-
2	B	-
3	W	-

Connector No.	F17
Connector Name	ENGINE COOLANT TEMPERATURE SENSOR
Connector Type	E02FGY-RS

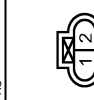

Terminal No.	Color of Wire	Signal Name [Specification]
1	Y	- [With VK engine]
1	SB	- [With VQ engine]
2	B	- [With VK engine]
2	B/W	- [With VQ engine]

Connector No.	F18
Connector Name	CAMSHAFT POSITION SENSOR (BANK 2)
Connector Type	RH03FB



Terminal No.	Color of Wire	Signal Name [Specification]
1	W	-
2	R	-
3	BR	-

Connector No.	F19
Connector Name	MANIFOLD ABSOLUTE PRESSURE SENSOR
Connector Type	RH03FB



Terminal No.	Color of Wire	Signal Name [Specification]
1	W	-
2	R	-
3	G	-

Connector No.	F21
Connector Name	INTAKE VALVE TIMING CONTROL SOLENOID VALVE BANK 2
Connector Type	E02FG-RS



Terminal No.	Color of Wire	Signal Name [Specification]
1	W	-
2	R	-
3	G	-

1	GR
2	G

Connector No.	F22
Connector Name	INTAKE VALVE TIMING CONTROL SOLENOID VALVE BANK 1
Connector Type	E02FG-RS

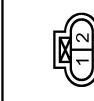

Terminal No.	Color of Wire	Signal Name [Specification]
1	SB	-
2	G	-

Connector No.	F23
Connector Name	APR FUEL RATIO (A/P) SENSOR 1 (BANK 1)
Connector Type	AFZ08FB



Terminal No.	Color of Wire	Signal Name [Specification]
2	Y	-
3	L/W	-
4	L/R	-
5	O	-
6	L	-

JRMWC9560GB

CONNECTOR INFORMATION

< WIRING DIAGRAM >

ENGINE CONTROL HARNESS

Connector No.	F24
Connector Name	AIR FUEL RATIO (A/F) SENSOR (BANK 2)
Connector Type	AF208FB



Terminal No.	Color of Wire	Signal Name [Specification]
2	P	-
3	L/R	-
4	L	-
5	O	-
6	L/W	-

Connector No.	F25
Connector Name	SHIMMIST VALVE TIMING CONTROL SOLENOID VALVE (BANK 2)
Connector Type	ED2FG-RS



Terminal No.	Color of Wire	Signal Name [Specification]
1	V	-
2	G	-

Connector No.	F26
Connector Name	SHIMMIST VALVE TIMING CONTROL SOLENOID VALVE (BANK 1)
Connector Type	ED2FG-RS



Terminal No.	Color of Wire	Signal Name [Specification]
1	R	-
2	G	-

Connector No.	F27
Connector Name	ELECTRIC THROTTLE CONTROL ACTUATOR (BANK 2)
Connector Type	RH08FB



Terminal No.	Color of Wire	Signal Name [Specification]
1	W/L	INPUT(TPS)
2	O/L	OUTPUT1(TPS)
3	W	OUTPUT2(TPS)
4	O	GRD(TPS)
5	LG	MOTOR2(CLOSE)
6	V	MOTOR1(OPEN)

Connector No.	F28
Connector Name	SHIMMIST VALVE TIMING CONTROL SOLENOID VALVE (BANK 1)
Connector Type	ED2FG-RS-LGY



Terminal No.	Color of Wire	Signal Name [Specification]
1	Y	-
2	W	-

Connector No.	F29
Connector Name	SHIMMIST VALVE TIMING CONTROL SOLENOID VALVE (BANK 2)
Connector Type	ED2FG-RS-LGY



Terminal No.	Color of Wire	Signal Name [Specification]
1	Y	-
2	W	-

Connector No.	F30
Connector Name	WIRE TO WIRE
Connector Type	RH08FB

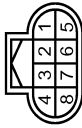

Terminal No.	Color of Wire	Signal Name [Specification]
1	G	-
2	GR	-
3	BR	-
4	Y	-
5	O	-
6	R	-
7	V	-

Connector No.	F31
Connector Name	MASS AIR FLOW SENSOR (BANK 1)
Connector Type	RH08FB



Terminal No.	Color of Wire	Signal Name [Specification]
1	V	-
2	Y	-
3	O	-
4	V	-
5	SB	-

Connector No.	F32
Connector Name	ENGINE OIL PRESSURE SENSOR
Connector Type	RH08FB

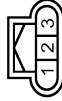

Terminal No.	Color of Wire	Signal Name [Specification]
1	B	-
2	Y	-
3	W	-

JRMWC9561GB

A
B
C
D
E
F
G
H
I
J
K
L
M
N
O
P

CONNECTOR INFORMATION

< WIRING DIAGRAM >

ENGINE CONTROL HARNESS

Connector No.	F35
Connector Name	POWER STEERING PRESSURE SENSOR
Connector Type	RK03FB

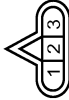

Terminal No.	Color of Wire	Signal Name [Specification]
1	V	- [With VK engine]
1	O	- [With VQ engine]
2	LG	- [With VK engine]
2	V	- [With VQ engine]
3	G	-

Connector No.	F36
Connector Name	ALTERNATOR
Connector Type	HS03FB



Terminal No.	Color of Wire	Signal Name [Specification]
2	G	-
3	L	-
4	P	-

Connector No.	F37
Connector Name	OIL PRESSURE SWITCH
Connector Type	E01FGY-RS-AR



Terminal No.	1	Color of Wire	LG	Signal Name [Specification]	-
--------------	---	---------------	----	-----------------------------	---

Connector No.	F38
Connector Name	ENGINE OIL TEMPERATURE SENSOR
Connector Type	E02FGY-RS



Terminal No.	Color of Wire	Signal Name [Specification]
1	L	- [With VK engine with ICC]
1	B	- [With VK engine without ICC]
1	G	- [With VQ engine]
2	B/W	- [With VK engine]
2	B/W	- [With VQ engine]

Connector No.	F39
Connector Name	LOW FUEL PRESSURE SENSOR
Connector Type	RH03FB



Terminal No.	1	Color of Wire	V	Signal Name [Specification]	-
2	B	Color of Wire	B	Signal Name [Specification]	-
3	G	Color of Wire	G	Signal Name [Specification]	-

Connector No.	F40
Connector Name	WIRE TO WIRE
Connector Type	SAA38FB-RSP-S1Z3



12	11	10	9	2	1
16	15	14	13	3	4
20	19	18	17	6	5
24	23	22	21	8	7

Terminal No.	Color of Wire	Signal Name [Specification]
1	L/W	-
2	SHIELD	-
3	L/B	-
4	SHIELD	-
5	L/W	-
6	R	- [With VK engine]
6	W	- [With VQ engine]
7	L/B	-
9	W	-
10	G	-
11	G	- [With VK engine]
12	W	- [With VQ engine]
13	P	-
14	V	-
15	R	-
16	O	- [With VK engine]
16	Y	- [With VQ engine]
19	L	-
20	GR	-
21	G	-
22	W	-
23	L	-
24	Y	-
25	LG	-
28	R	-
29	W	-
30	B	-
31	V	-
32	LG	- [With VK engine]
32	BR	- [With VQ engine]
33	Y	- [With VK engine]
33	P	- [With VQ engine]
34	O	-
37	SHIELD	-
38	L/G	- [With VK engine]
38	O/L	- [With VQ engine]
39	L/Y	- [With VK engine]

39	P	- [With VQ engine]
40	W/L	-
41	O/L	- [With VK engine]
41	W	- [With VQ engine]
42	O	- [With VK engine]
42	LG	- [With VQ engine]
43	W	- [With VK engine]
43	O	- [With VQ engine]
46	SHIELD	-
47	L/G	- [With VK engine]
47	W	- [With VQ engine]
48	L/Y	- [With VK engine]
48	BR	- [With VQ engine]
49	W/L	- [With VK engine]
49	O/L	- [With VQ engine]
50	W/L	- [With VK engine]
51	O	- [With VQ engine]
51	SS	- [With VK engine]
52	W	- [With VQ engine]
52	O	- [With VQ engine]

Connector No.	F41
Connector Name	CONDENSER
Connector Type	M02FW-GY-LC



Terminal No.	1	Color of Wire	W	Signal Name [Specification]	-
2	B	Color of Wire	B	Signal Name [Specification]	-

JRMWC9562.GB

CONNECTOR INFORMATION

< WIRING DIAGRAM >

ENGINE CONTROL HARNESS

Connector No.	F42
Connector Name	MASS AIR FLOW SENSOR (BANK 2)
Connector Type	RH08FB



Terminal No.	Color of Wire	Signal Name [Specification]
3	BR	-
4	B	-
5	V	-

Connector No.	F43
Connector Name	COMPRESSOR
Connector Type	RK02FGY



Terminal No.	Color of Wire	Signal Name [Specification]
2	O	-
3	BR	-

Connector No.	F44
Connector Name	COMPRESSOR
Connector Type	FSD1FB



Terminal No.	Color of Wire	Signal Name [Specification]
1	P	-

Connector No.	F45
Connector Name	POWER STEERING SOLENOID VALVE
Connector Type	FSD2FBR-DGY



Terminal No.	Color of Wire	Signal Name [Specification]
1	LG	-
2	B	-

Connector No.	F46
Connector Name	VVEL CONTROL SHAFT POSITION SENSOR (BANK 1)
Connector Type	RH08FB

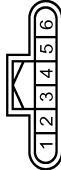

Terminal No.	Color of Wire	Signal Name [Specification]
1	O	-
2	W	-
3	LG	-
4	W/L	-
5	O/L	-
6	P	-

Connector No.	F47
Connector Name	VVEL CONTROL SHAFT POSITION SENSOR (BANK 2)
Connector Type	RH08FB

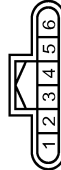

Terminal No.	Color of Wire	Signal Name [Specification]
1	O	-
2	W/L	-
3	SB	-
4	O/L	-
5	W	-
6	BR	-

Connector No.	F48
Connector Name	VVEL ACTUATOR MOTOR (BANK 1)
Connector Type	X02FB



Terminal No.	Color of Wire	Signal Name [Specification]
1	L/B	-
2	L/W	-

Connector No.	F49
Connector Name	VVEL ACTUATOR MOTOR (BANK 2)
Connector Type	X02FB



Terminal No.	Color of Wire	Signal Name [Specification]
1	L/B	-
2	L/W	-

Connector No.	F50
Connector Name	MANIFOLD ABSOLUTE PRESSURE (MAP) SENSOR
Connector Type	RH03FB



Terminal No.	Color of Wire	Signal Name [Specification]
1	G	-
2	W	-
3	O	-

Connector No.	F51
Connector Name	STARTER MOTOR
Connector Type	X01FGY



Terminal No.	Color of Wire	Signal Name [Specification]
1	R	-

Connector No.	F52
Connector Name	STARTER MOTOR
Connector Type	X01MGY



Terminal No.	Color of Wire	Signal Name [Specification]
1	W	-

JRMWC9563.GB

A
B
C
D
E
F
G
H
I
J
K
L
PG
N
O
P

CONNECTOR INFORMATION

< WIRING DIAGRAM >

ENGINE CONTROL HARNESS

Connector No.	F53
Connector Name	HEATED OXYGEN SENSOR 2 (BANK 2)
Connector Type	AF204FB



Terminal No.	Color of Wire	Signal Name [Specification]
1	B/W	-
2	V	-
3	LG	-
4	L	-

Connector No.	F54
Connector Name	HEATED OXYGEN SENSOR 2 (BANK 1)
Connector Type	AF204FB



Terminal No.	Color of Wire	Signal Name [Specification]
1	B/W	-
2	V	-
3	P	-
4	BR	-

Connector No.	F55
Connector Name	POWER STEERING SOLENOID VALVE
Connector Type	RH02FB



Terminal No.	Color of Wire	Signal Name [Specification]
1	LG	-
2	B	-



Connector No.	F57
Connector Name	AWD SOLENOID
Connector Type	FK08FB



Terminal No.	Color of Wire	Signal Name [Specification]
1	GR	ETS_SQ+
2	R	ETS_SQ-
6	LG	OIL_TEMP+
7	W	OIL_TEMP-

Connector No.	F59
Connector Name	EXHAUST VALVE TIMING CONTROL POSITION SENSOR (BANK 1)
Connector Type	RH08FB



Terminal No.	Color of Wire	Signal Name [Specification]
1	B	-
2	L	-
3	R	-

Connector No.	F60
Connector Name	WIRE TO WIRE
Connector Type	FRS0FB-PR



Terminal No.	Color of Wire	Signal Name [Specification]
1	L	-
2	BR	-
3	L	-
4	Y	-
5	B/W	-
6	Y	-
7	B/W	-
8	BR	-

Connector No.	F61
Connector Name	A/T ASSEMBLY
Connector Type	FR10FG-DGY

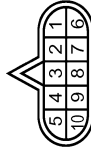

Terminal No.	Color of Wire	Signal Name [Specification]
1	Y	POWER SUPPLY (BACK UP)
2	R	POWER SUPPLY (BACK UP)
3	L	HEV SYSTEM CAN-H
4	V	R-LINE
5	B	GND
6	G	POWER SUPPLY (IGN)
7	SB	BACK-UP LAMP RELAY
8	P	HEV SYSTEM CAN-L
9	LG	P/N SIGNAL [With paddle shifter]
9	BR	P/N SIGNAL [Without paddle shifter]
10	B	GROUND

Connector No.	F63
Connector Name	EXHAUST VALVE TIMING CONTROL POSITION SENSOR (BANK 2)
Connector Type	FR08FB



Terminal No.	Color of Wire	Signal Name [Specification]
1	L	-
2	R	-
3	B	-

Connector No.	F64
Connector Name	ELECTRIC THROTTLE CONTROL ACTUATOR (BANK 2)
Connector Type	HS08FB



Terminal No.	Color of Wire	Signal Name [Specification]
1	O	OUTPUT1(TPS)
2	W	INPUT(TPS)
3	W/L	OUTPUT2(TPS)
4	O/L	GND(TPS)
5	G	MOTOR-(CLOSE)
6	R	MOTOR-(OPEN)

JRMWC9564GB

CONNECTOR INFORMATION

< WIRING DIAGRAM >

ENGINE CONTROL HARNESS

Connector No.	F66
Connector Name	ELECTRIC THROTTLE CONTROL ACTUATOR (BANK 1)
Connector Type	RH06FB



Terminal No.	Color of Wire	Signal Name [Specification]
1	R	OUTPUT1(TPS)
2	W	INPUT1(TPS)
3	B	OUTPUT2(TPS)
4	G	INPUT2(TPS)
5	P	GND(TPS)
6	L	MOTOR-(CLOSE) MOTOR+(OPEN)

Connector No.	F67
Connector Name	ELECTRIC THROTTLE CONTROL ACTUATOR (BANK 1)
Connector Type	RH06FB



Terminal No.	Color of Wire	Signal Name [Specification]
1	G	MOTOR1(OPEN)
2	BR	MOTOR2(CLOSE)
3	O/L	GND(TPS)
4	O	OUTPUT1(TPS)
5	W/L	OUTPUT2(TPS)
6	W	INPUT1(TPS)

Connector No.	F68
Connector Name	WIRE TO WIRE
Connector Type	RS4MB



Terminal No.	Color of Wire	Signal Name [Specification]
1	SHIELD	-
2	W	-
3	SHIELD	-
4	GR	-

Connector No.	F69
Connector Name	WIRE TO WIRE
Connector Type	RS8FB-PR

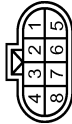

Terminal No.	Color of Wire	Signal Name [Specification]
1	B/W	-
2	Y	-
3	L	-
4	Y	-
5	L	-
6	BR	-
7	B/W	-
8	BR	-

Connector No.	F70
Connector Name	VVEL CONTROL SHIF POSITION SENSOR (BANK 2)
Connector Type	RH06FB

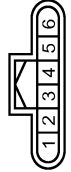

Terminal No.	Color of Wire	Signal Name [Specification]
1	O	-
2	O/L	-
3	W	-
4	W/L	-
5	L/Y	-
6	L/G	-

Connector No.	F71
Connector Name	VVEL ACTUATOR MOTOR (BANK 2)
Connector Type	X02FB



Terminal No.	Color of Wire	Signal Name [Specification]
1	L/B	-
2	L/W	-

Connector No.	F72
Connector Name	VVEL CONTROL SHIF POSITION SENSOR (BANK 0)
Connector Type	RH06FB



Terminal No.	Color of Wire	Signal Name [Specification]
1	O	-
2	O/L	-
3	W	-
4	W/L	-
5	L/Y	-
6	L/G	-

Connector No.	F73
Connector Name	VVEL ACTUATOR MOTOR (BANK 1)
Connector Type	X02FB



Terminal No.	Color of Wire	Signal Name [Specification]
1	L/B	-
2	L/W	-

Connector No.	F74
Connector Name	APF FUEL RATIO (A/F) SENSOR 1 (BANK 1)
Connector Type	FR04MG1-BR



Terminal No.	Color of Wire	Signal Name [Specification]
1	L/O	-
2	W/L	-
3	L	-
4	Y	-

JRMWC9565GB

A
B
C
D
E
F
G
H
I
J
K
L
N
O
P

CONNECTOR INFORMATION

< WIRING DIAGRAM >

ENGINE CONTROL HARNESS

Connector No.	F75
Connector Name	AIR FUEL RATIO (A/F) SENSOR 1 (BANK 1)
Connector Type	RH18MDCY-BR

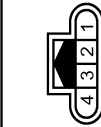

Terminal No.	Color of Wire	Signal Name [Specification]
1	L	-
2	B/W	-
3	W	-
4	Y	-

Connector No.	F83
Connector Name	CRANKSHAFT POSITION SENSOR (BANK 2)
Connector Type	RH103FB

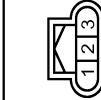

Terminal No.	Color of Wire	Signal Name [Specification]
1	L	-
2	R	-
3	B	-

Connector No.	F84
Connector Name	CRANKSHAFT POSITION SENSOR (BANK 1)
Connector Type	RH103FB

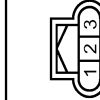

Terminal No.	Color of Wire	Signal Name [Specification]
1	B	-
2	L	-
3	R	-

Connector No.	F85
Connector Name	MASS AIR FLOW SENSOR (BANK 2)
Connector Type	RH108FB

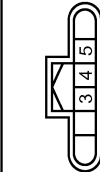

Terminal No.	Color of Wire	Signal Name [Specification]
3	B	-
4	O	-
5	BR	-

Connector No.	F86
Connector Name	MASS AIR FLOW SENSOR (BANK 1)
Connector Type	RH108FB

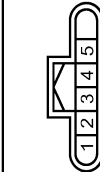

Terminal No.	Color of Wire	Signal Name [Specification]
1	P	-
2	R	-
3	GR	-
4	P	-
5	BR	-

Connector No.	F87
Connector Name	HEATED OXYGEN SENSOR 2 (BANK 1)
Connector Type	AFZ04FB



Terminal No.	Color of Wire	Signal Name [Specification]
1	P	-
2	V	-
3	BR	-
4	Y	-

Connector No.	F88
Connector Name	HEATED OXYGEN SENSOR 2 (BANK 2)
Connector Type	AFZ04FB



Terminal No.	Color of Wire	Signal Name [Specification]
1	P	-
2	V	-
3	G	-
4	BR	-

Connector No.	F89
Connector Name	IGNITION COIL No. 1 (WITH POWER TRANSISTOR)
Connector Type	ED03FGY-RS



Terminal No.	Color of Wire	Signal Name [Specification]
1	O	-
2	B	-
3	W/B	-

Connector No.	F92
Connector Name	IGNITION COIL No. 2 (WITH POWER TRANSISTOR)
Connector Type	ED03FGY-RS



Terminal No.	Color of Wire	Signal Name [Specification]
1	L	-
2	B	-
3	W	-

Connector No.	F93
Connector Name	IGNITION COIL No. 3 (WITH POWER TRANSISTOR)
Connector Type	ED03FGY-RS

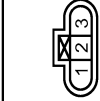

Terminal No.	Color of Wire	Signal Name [Specification]
1	G	-
2	B	-
3	W	-

JRMWC9566GB

CONNECTOR INFORMATION

< WIRING DIAGRAM >

ENGINE CONTROL HARNESS

Connector No.	F94
Connector Name	IGNITION COIL No. 4 (WITH POWER TRANSISTOR)
Connector Type	E03FGY-RS



Terminal No.	Color of Wire	Signal Name [Specification]
1	R	-
2	B	-
3	W	-

Connector No.	F95
Connector Name	IGNITION COIL No. 5 (WITH POWER TRANSISTOR)
Connector Type	E03FGY-RS



Terminal No.	Color of Wire	Signal Name [Specification]
1	LG	-
2	B	-
3	W	-

Connector No.	F96
Connector Name	IGNITION COIL No. 6 (WITH POWER TRANSISTOR)
Connector Type	E03FGY-RS



Terminal No.	Color of Wire	Signal Name [Specification]
1	LG	-
2	B	-
3	W	-

1	V
2	B
3	W

Connector No.	F37
Connector Name	IGNITION COIL No. 7 (WITH POWER TRANSISTOR)
Connector Type	E03FGY-RS



Terminal No.	Color of Wire	Signal Name [Specification]
1	L	-
2	B	-
3	W	-

Connector No.	F38
Connector Name	IGNITION COIL No. 8 (WITH POWER TRANSISTOR)
Connector Type	E03FGY-RS



Terminal No.	Color of Wire	Signal Name [Specification]
1	G	-
2	B	-
3	W	-

Connector No.	F101
Connector Name	ECM
Connector Type	RH40FB-R28-L-RH-Z

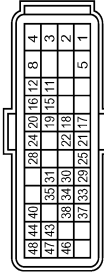

Terminal No.	Color of Wire	Signal Name [Specification]
1	W	A/F SENSOR 1 HEATER (BANK 1)
2	G	THROTTLE CONTROL MOTOR (BANK 1) (OPEN)
3	R	THROTTLE CONTROL MOTOR POWER SUPPLY (BANK 1)
4	BR	THROTTLE CONTROL MOTOR (BANK 1) (CLOSE)
5	L	A/F SENSOR 1 HEATER (BANK 2)
8	B	ECM GROUND
11	GR	IGNITION SIGNAL No. 4
12	L	IGNITION SIGNAL No. 3
15	LG	IGNITION SIGNAL No. 5
16	G	IGNITION SIGNAL No. 2
17	P	HEATED OXYGEN SENSOR 2 HEATER (BANK 1)
18	Y	INTAKE VALVE TIMING CONTROL SOLENOID VALVE (BANK 1)
19	Y	IGNITION SIGNAL No. 6
20	Y	IGNITION SIGNAL No. 1
21	GR	EVAP CANISTER PURGE VOLUME CONTROL SOLENOID VALVE
22	B	FUEL PUMP RELAY
24	V	ECM RELAY (SELF SHUT-OFF)
25	O	THROTTLE CONTROL MOTOR RELAY
28	R	INTEK ACTUATOR MOTOR RELAY (ASBFT (BANK TYPE CONTROL) (BANK 2))
29	Y	INTAKE VALVE TIMING CONTROL SOLENOID VALVE (BANK 2)
30	O	THROTTLE POSITION SENSOR 1 (BANK 1)
31	O/L	THROTTLE POSITION SENSOR 1 (BANK 2)
33	LG	HEATED OXYGEN SENSOR 2 HEATER (BANK 2)
34	W/L	THROTTLE POSITION SENSOR 2 (BANK 1)
35	W	THROTTLE POSITION SENSOR 2 (BANK 2)
37	L	CRANKSHAFT POSITION SENSOR
38	W	MANIFOLD ABSOLUTE PRESSURE SENSOR
40	O/L	SENSOR GROUND
43	W/L	SENSOR POWER SUPPLY (THROTTLE POSITION SENSOR (BANK 2))
44	W	SENSOR POWER SUPPLY (THROTTLE POSITION SENSOR (BANK 1))
46	R	AVCC POS
47	B	GND POS
48	O	SENSOR GROUND

JRMWC9567GB

A
B
C
D
E
F
G
H
I
J
K
L
PG
N
O
P

CONNECTOR INFORMATION

< WIRING DIAGRAM >

ENGINE CONTROL HARNESS

Connector No.	F102
Connector Name	ECM
Connector Type	RH40BFR-R28-L RH-Z

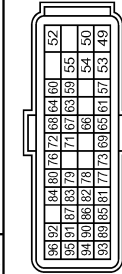

Terminal No.	Color of Wire	Signal Name [Specification]
48	LG	THROTTLE CONTROL MOTOR (BANK 2) (CLOSE)
50	V	THROTTLE CONTROL MOTOR (BANK 2) (OPEN)
52	R	THROTTLE CONTROL MOTOR RELAY POWER SUPPLY (BANK 2)
53	G	IGNITION SWITCH
54	L	CAN COMMUNICATION LINE (VEHICLE CONTROL MODULE)
55	Y	CAN COMMUNICATION LINE (VEHICLE CONTROL MODULE)
57	L	A/F SENSOR 1 (BANK 1)
58	L	CAMSHAFT POSITION SENSOR (BANK 1)
60	G	AVCC PHIS-E PHIS/PS
61	B/W	A/F SENSOR 1 (BANK 1)
63	BR	CAMSHAFT POSITION SENSOR (BANK 2)
64	W	AVCC PHIS-E PHIS/OU
65	L/O	A/F SENSOR 1 (BANK 2)
66	W/L	A/F SENSOR 1 (BANK 2)
67	Y	INTAKE AIR TEMPERATURE SENSOR (BANK 1)
68	V	GNDA QAL/TAI
69	GR	KNOCK SENSOR (BANK 2)
71	SB	ENGINE COOLANT TEMPERATURE SENSOR
72	SHIELD	SENSOR GROUND (KNOCK SENSOR)
73	W	KNOCK SENSOR (BANK 1)
76	BR	HEATED OXYGEN SENSOR 2 (BANK 1)
77	O	MASS AIR FLOW SENSOR (BANK 1)
78	G	ENGINE OIL TEMPERATURE SENSOR
79	BR	MASS AIR FLOW SENSOR (BANK 2)
80	L	HEATED OXYGEN SENSOR 2 (BANK 2)
81	Y	FUEL INJECTOR No. 3
82	V	FUEL INJECTOR No. 6
83	GR	BATT TEMP
84	B/W	SENSOR GROUND
85	BR	FUEL INJECTOR No. 2
86	R	FUEL INJECTOR No. 5
87	V	POWER STEERING PRESSURE SENSOR
89	GR	FUEL INJECTOR No. 1
90	O	FUEL INJECTOR No. 4
91	G	BATTERY CURRENT SENSOR
92	R	GNDA PHASE#2
93	W	POWER SUPPLY FOR ECM (BACK-UP)
94	B	GNDA QAZ

95	W	GNDA CURSEN
96	O	GNDA PHASE#1/PS

Connector No.	F103
Connector Name	WIRE TO WIRE
Connector Type	TK38FW-NS10

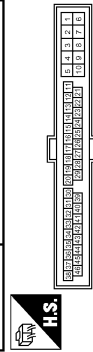

Terminal No.	Color of Wire	Signal Name [Specification]
2	L	-
3	G	-
4	B	- [With VK engine]
4	R	- [With VO engine]
5	GR	- [With VK engine]
5	B	- [With VO engine]
7	LG	-
8	Y	-
9	W	- [With VK engine]
9	SB	- [With VO engine]
10	BR	- [With VK engine]
10	V	- [With VO engine]
11	L	-
12	P	-
13	V	-
14	SB	-
15	R	-
16	W	-
17	GR	-
18	LG	-
21	LG	-
22	B	-
23	G	-
24	BR	-
25	O	-

Connector No.	F110
Connector Name	ECM
Connector Type	MA85SFB-ME85D-LH-Z

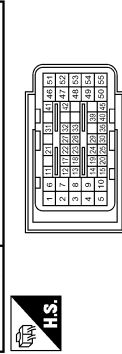

Terminal No.	Color of Wire	Signal Name [Specification]
1	Y	FUEL INJECTOR No. 8 (HI)
2	L	FUEL INJECTOR No. 3 (HI)
3	Y	FUEL INJECTOR No. 3 (LO)
4	L	FUEL INJECTOR No. 2 (LO)
5	B	ECM GROUND
6	BR	FUEL INJECTOR No. 3 (HI)
7	B/W	FUEL INJECTOR No. 2 (HI)
8	BR	FUEL INJECTOR No. 8 (LO)
9	B/W	FUEL INJECTOR No. 5 (LO)
10	GR	ECM GROUND
11	LG	TRANSMISSION RANGE SWITCH
12	O	IGNITION SIGNAL No. 1
13	L	IGNITION SIGNAL No. 2
14	G	IGNITION SIGNAL No. 3
15	R	IGNITION SIGNAL No. 4
17	LQ	IGNITION SIGNAL No. 5
18	Y	IGNITION SIGNAL No. 6
19	L	IGNITION SIGNAL No. 7
20	G	IGNITION SIGNAL No. 8
21	R	INTAKE AIR TEMPERATURE SENSOR (BANK 1)
22	GR	MASS AIR FLOW SENSOR (BANK 1) [With ICC]
22	B	MASS AIR FLOW SENSOR (BANK 1) [Without ICC]
23	B	LOW FUEL PRESSURE SENSOR
24	B	MASS AIR FLOW SENSOR (BANK 2) [With ICC]
24	GR	MASS AIR FLOW SENSOR (BANK 2) [Without ICC]
25	P	SENSOR GROUND
27	G	SENSOR POWER SUPPLY
28	W	SENSOR POWER SUPPLY
29	W	KNOCK SENSOR (BANK 1)
30	O	SENSOR GROUND
31	G	FUEL RAIL PRESSURE SENSOR
32	Y	ENGINE COOLANT TEMPERATURE SENSOR
33	GR	KNOCK SENSOR (BANK 2)
35	SHIELD	SENSOR GROUND
39	LQ	POWER STEERING PRESSURE SENSOR
40	B	SENSOR GROUND
41	Y	ENGINE OIL PRESSURE SENSOR
42	L	ENGINE OIL TEMPERATURE SENSOR [With ICC]

42	B	ENGINE OIL TEMPERATURE SENSOR [Without ICC]
45	V	SENSOR GROUND
46	LG	FUEL INJECTOR DRIVER POWER SUPPLY
47	BR	HEATED OXYGEN SENSOR 2 HEATER (BANK 1)
48	Y	A/F SENSOR 1 HEATER (BANK 1)
49	GR	INTAKE AIR TEMPERATURE SENSOR (BANK 2)
50	V	EXHAUST VALVE TIMING CONTROL SOLENOID VALVE (BANK 2)
51	W	FUEL INJECTOR DRIVER POWER SUPPLY
52	G	HEATED OXYGEN SENSOR 2 HEATER (BANK 2)
53	P	A/F SENSOR 1 HEATER (BANK 2)
54	SB	INTAKE AIR TEMPERATURE SENSOR (BANK 1)
55	R	EXHAUST VALVE TIMING CONTROL SOLENOID VALVE (BANK 1)

JRMWC9568GB

CONNECTOR INFORMATION

< WIRING DIAGRAM >

ENGINE CONTROL HARNESS

Connector No.	F111
Connector Name	ECM
Connector Type	MAESSEFER-ME820-LH-Z

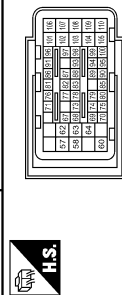

Terminal No.	Color of Wire	Signal Name [Specification]
57	L	THROTTLE CONTROL MOTOR (BANK 1) (OPEN)
58	G	THROTTLE CONTROL MOTOR (BANK 2) (CLOSE)
60	B/W	SHIELD
62	R	THROTTLE CONTROL MOTOR (BANK 2) (OPEN)
63	P	THROTTLE CONTROL MOTOR (BANK 1) (CLOSE)
64	GR	EVAP CANISTER PURGE VOLUME CONTROL SOLENOID VALVE
67	R	MANIFOLD ABSOLUTE PRESSURE SENSOR
68	L	SENSOR GROUND
69	O/L	SENSOR GROUND
70	G	SENSOR GROUND
71	O	THROTTLE POSITION SENSOR 1 (BANK 2)
73	B	CAMSHAFT POSITION SENSOR (BANK 2)
74	L/W	A/F SENSOR 1 (BANK 2)
75	R	EXHAUST VALVE TIMING CONTROL POSITION SENSOR (BANK 1)
76	B	SENSOR POWER SUPPLY
77	B	SENSOR POWER SUPPLY
78	L/R	A/F SENSOR 1 (BANK 2)
79	B	THROTTLE POSITION SENSOR 2 (BANK 1)
80	L	A/F SENSOR 1 (BANK 2)
81	W	SENSOR POWER SUPPLY
82	W	SENSOR POWER SUPPLY
83	L	SENSOR POWER SUPPLY
85	W	SENSOR POWER SUPPLY
86	L	CRANKSHAFT POSITION SENSOR
87	BR	HEATED OXYGEN SENSOR 2 (BANK 2)
88	L/W	A/F SENSOR 1 (BANK 1)
89	W/L	THROTTLE POSITION SENSOR 2 (BANK 2)
90	L/R	A/F SENSOR 1 (BANK 1)
91	R	THROTTLE POSITION SENSOR 1 (BANK 1)
93	B	EXHAUST VALVE TIMING CONTROL POSITION SENSOR (BANK 2)
94	L	A/F SENSOR 1 (BANK 1)
95	R	INTAKE CAMSHAFT POSITION SENSOR (BANK 1)
96	Y	HEATED OXYGEN SENSOR 2 (BANK 1)
97	G	SENSOR GROUND
98	R	SENSOR GROUND
99	R	SENSOR GROUND
100	P	SENSOR GROUND
101	Y	FUEL INJECTOR No. 1 (H)

102	L	FUEL INJECTOR No. 6 (H)
103	B/W	FUEL INJECTOR No. 7 (L/O)
104	BR	FUEL INJECTOR No. 1 (L/O)
105	W	HIGH PRESSURE FUEL PUMP (H)
106	L	FUEL INJECTOR No. 7 (H)
107	Y	FUEL INJECTOR No. 4 (H)
108	BR	FUEL INJECTOR No. 1 (L/O)
109	B/W	FUEL INJECTOR No. 6 (L/O)
110	B	HIGH PRESSURE FUEL PUMP (L/O)

Connector No.	F120
Connector Name	WIRE TO WIRE
Connector Type	RH08MB

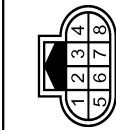

Terminal No.	Color of Wire	Signal Name [Specification]
1	G	-
2	GR	-
3	BR	-
4	R	-
5	O	-
6	W	-
7	V	-

Connector No.	F121
Connector Name	FUEL INJECTOR No. 1
Connector Type	HSZ2FGY



Terminal No.	Color of Wire	Signal Name [Specification]
1	G	-
2	GR	-

Connector No.	F122
Connector Name	FUEL INJECTOR No. 2
Connector Type	HSZ2FGY



Terminal No.	Color of Wire	Signal Name [Specification]
1	G	-
2	BR	-

Connector No.	F123
Connector Name	FUEL INJECTOR No. 3
Connector Type	HSZ2FGY



Terminal No.	Color of Wire	Signal Name [Specification]
1	G	-
2	R	-

Connector No.	F124
Connector Name	FUEL INJECTOR No. 4
Connector Type	HSZ2FGY



Terminal No.	Color of Wire	Signal Name [Specification]
1	G	-
2	O	-

Connector No.	F125
Connector Name	FUEL INJECTOR No. 5
Connector Type	HSZ2FGY

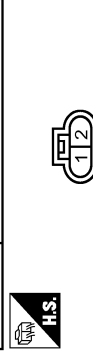

Terminal No.	Color of Wire	Signal Name [Specification]
1	G	-
2	W	-

Connector No.	F126
Connector Name	FUEL INJECTOR No. 6
Connector Type	HSZ2FGY

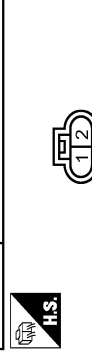

Terminal No.	Color of Wire	Signal Name [Specification]
1	G	-
2	V	-

JRMWC9569GB

A B C D E F G H I J K L N O P PG

CONNECTOR INFORMATION

< WIRING DIAGRAM >

ENGINE CONTROL HARNESS

Connector No.	F130
Connector Name	WIRE TO WIRE
Connector Type	RS38MB-PR

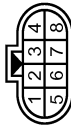

Terminal No.	Color of Wire	Signal Name [Specification]
1	P	-
2	BR	-
3	G	-
4	W	-
5	O	-
6	LG	-
7	Y	-
8	R	-

Connector No.	F131
Connector Name	FUEL INJECTOR No. 1
Connector Type	HSD2FGY



Terminal No.	Color of Wire	Signal Name [Specification]
1	W	-
2	R	-

Connector No.	F132
Connector Name	FUEL INJECTOR No. 2
Connector Type	HSD2FGY



Terminal No.	Color of Wire	Signal Name [Specification]
1	Y	-
2	R	-

Connector No.	F133
Connector Name	FUEL INJECTOR No. 3
Connector Type	HSD2FGY



Terminal No.	Color of Wire	Signal Name [Specification]
1	BR	-
2	LG	-

Connector No.	F134
Connector Name	FUEL INJECTOR No. 4
Connector Type	HSD2FGY



Terminal No.	Color of Wire	Signal Name [Specification]
1	GR	-
2	SB	-

Connector No.	F135
Connector Name	FUEL INJECTOR No. 5
Connector Type	HSD2FGY



Terminal No.	Color of Wire	Signal Name [Specification]
1	P	-
2	O	-

Connector No.	F136
Connector Name	FUEL INJECTOR No. 6
Connector Type	HSD2FGY



Terminal No.	Color of Wire	Signal Name [Specification]
1	V	-
2	W	-

Connector No.	F137
Connector Name	FUEL INJECTOR No. 7
Connector Type	HSD2FGY



Terminal No.	Color of Wire	Signal Name [Specification]
1	G	-
2	Y	-

Connector No.	F138
Connector Name	FUEL INJECTOR No. 8
Connector Type	HSD2FGY



Terminal No.	Color of Wire	Signal Name [Specification]
1	R	-
2	G	-

Connector No.	F139
Connector Name	WIRE TO WIRE
Connector Type	RS38MB-PR

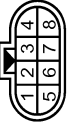

Terminal No.	Color of Wire	Signal Name [Specification]
1	Y	-
2	R	-
3	V	-
4	GR	-
5	R	-
6	G	-
7	W	-
8	SB	-

JRMWC9570GB

CONNECTOR INFORMATION

< WIRING DIAGRAM >

ENGINE CONTROL HARNESS

Connector No.	F201
Connector Name	WIRE TO WIRE
Connector Type	F35AML-B



Terminal No.	Color of Wire	Signal Name [Specification]
1	W	-
2	SHIELD	-
3	W	-
4	SHIELD	-

Connector No.	F202
Connector Name	KNOCK SENSOR (BANK 2)
Connector Type	ED2FG-RS-LGY



Terminal No.	Color of Wire	Signal Name [Specification]
1	W	-
2	SHIELD	-

Connector No.	F203
Connector Name	KNOCK SENSOR (BANK 1)
Connector Type	ED2FG-RS-LGY



Terminal No.	Color of Wire	Signal Name [Specification]
1	W	-
2	SHIELD	-

1	W	-
2	SHIELD	-

Connector No.	F211
Connector Name	WIRE TO WIRE
Connector Type	F354FB-PR



Terminal No.	Color of Wire	Signal Name [Specification]
1	SHIELD	-
2	W	-
3	SHIELD	-
4	GR	-

Connector No.	F212
Connector Name	KNOCK SENSOR (BANK 1)
Connector Type	ED2FB-RS



Terminal No.	Color of Wire	Signal Name [Specification]
1	W	-
2	SHIELD	-

Connector No.	F213
Connector Name	KNOCK SENSOR (BANK 2)
Connector Type	ED2FB-RS



Terminal No.	Color of Wire	Signal Name [Specification]
1	GR	-
2	SHIELD	-

Connector No.	F301
Connector Name	TCM (TRANSMISSION CONTROL MODULE)
Connector Type	SPI (PFC)

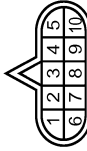

Terminal No.	Color of Wire	Signal Name [Specification]
1	-	VIGN
2	-	BATT
3	-	CAN-H
4	-	K LINE
5	-	GND
6	-	VIGN
7	-	REV LAMP RLY
8	-	CAN-L
9	-	START RLY
10	-	GND

Connector No.	F309
Connector Name	TRANSMISSION RANGE SWITCH
Connector Type	AG3FW

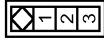

Terminal No.	Color of Wire	Signal Name [Specification]
1	-	GND
2	-	VOUT
3	-	VCC

A
B
C
D
E
F
G
H
I
J
K
L
PG
N
O
P

CONNECTOR INFORMATION

< WIRING DIAGRAM >

M Main Harness

INFOID:000000008131349

MAIN HARNESS

Connector No.	M1
Connector Name	FUSE BLOCK (J/B)
Connector Type	NSDBFW-M2



Terminal No.	Color of Wire	Signal Name [Specification]
1A	R	-
2A	W	-
3A	Y	-
4A	W	-
5A	V	-
6A	Y	-
8A	Y	-

Connector No.	M2
Connector Name	FUSE BLOCK (J/B)
Connector Type	NS10FW-CS

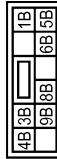

Terminal No.	Color of Wire	Signal Name [Specification]
1B	R	-
3B	P	-
4B	G	-
5B	SB	-
6B	W	-
8B	R	-
9B	R	-

Connector No.	M3
Connector Name	FUSE BLOCK (J/B)
Connector Type	NS12FW-CS

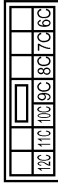

Terminal No.	Color of Wire	Signal Name [Specification]
6C	R	-
7C	B	-
8C	B	-
9C	L	-
10C	LG	-
11C	LG	-
12C	O	-

Connector No.	M4
Connector Name	WIRE TO WIRE
Connector Type	NS16FW-CS



Terminal No.	Color of Wire	Signal Name [Specification]
4	B	-
5	W	-
6	G	-
7	R	-
13	G	-
14	W	-
15	R	-
16	B	-

Connector No.	M5
Connector Name	WIRE TO WIRE
Connector Type	ADDFW

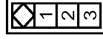

Terminal No.	Color of Wire	Signal Name [Specification]
1	G	-
2	R	-
3	SHIELD	-

Connector No.	M6
Connector Name	WIRE TO WIRE
Connector Type	TH80MH-CS (6-TM)

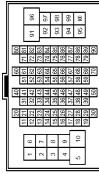

Terminal No.	Color of Wire	Signal Name [Specification]
1	W	-
2	W	-
3	SB	-
4	LG	-
5	W	-
7	BG	-
8	G	-
9	Y	-
10	W	-
11	R	-
12	V	-
13	LG	-
14	L	-
15	V	-
16	B	-
17	GR	-
18	V	-
20	SB	-
21	BR	-

22	L	-
23	P	-
27	SHIELD	-
28	V	-
29	SB	-
31	BG	-
32	P	-
33	R	-
34	BG	-
41	BR	-
44	BR	-
45	Y	-
46	BG	-
47	V	-
48	G	-
49	BG	-
50	W	-
60	GR	-
61	B	-
62	LG	-
63	BR	-
64	L	- [Except for Federal with ZWH sport advanced technology]
64	SB	- [For Federal with ZWH sport advanced technology]
65	R	- [Except for Federal with ZWH sport advanced technology]
65	Y	- [For Federal with ZWH sport advanced technology]
66	P	- [Except for Federal with ZWH sport advanced technology]
66	R	- [For Federal with ZWH sport advanced technology]
67	L	-
77	B	-
78	V	-
80	G	-
81	L	-
82	B	-
83	BG	-
84	SB	-
85	Y	-
86	L	-
87	V	-
88	V	-
89	LG	-
90	BG	-
91	W	-
92	BG	-
93	G	-
94	Y	-
95	W	-
96	R	-
97	SB	-
98	R	-
99	W	-
100	L	-

CONNECTOR INFORMATION

< WIRING DIAGRAM >

MAIN HARNESS

Connector No.	M7
Connector Name	WIRE TO WIRE
Connector Type	TH80MW-CS16-TM4

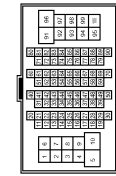

Terminal No.	Color of Wire	Signal Name [Specification]
1	G	-
2	Y	-
4	BR	-
5	P	-
6	W	-
7	G	-
8	Y	-
9	G	-
10	V	-
11	V	- [With climate controlled seat]
11	L	- [With heated seat]
12	P	- [With climate controlled seat]
12	GR	- [With heated seat]
13	BR	-
14	GR	-
15	BG	-
16	V	-
17	BG	-
18	L	-
19	W	-
20	R	-
21	B	-
22	LG	-
23	W	-
24	V	-
25	G	-
26	BR	-
27	SB	-
28	P	-
29	L	-
30	SHIELD	-
32	L	-
33	P	-
34	L	-
35	P	-
36	BG	-
37	SB	-
41	SB	-

Connector No.	M8
Connector Name	RESISTOR
Connector Type	M02FBR-LC



Terminal No.	Color of Wire	Signal Name [Specification]
1	L	-
2	B	-

Connector No.	M9
Connector Name	ACCELERATOR PEDAL POSITION SENSOR
Connector Type	FRD0FEB



Terminal No.	Color of Wire	Signal Name [Specification]
1	Y	ACCELERATOR PEDAL POSITION SENSOR 2
2	B	SENSOR GROUND
3	R	SENSOR POWER SUPPLY
4	W	ACCELERATOR PEDAL POSITION SENSOR 1
5	G	SENSOR GROUND
6	L	SENSOR POWER SUPPLY

Connector No.	M10
Connector Name	DIODE
Connector Type	24335-C9802



Terminal No.	Color of Wire	Signal Name [Specification]
1	B	-
2	B	-

Connector No.	M12
Connector Name	WIRE TO WIRE
Connector Type	TH24MW-NH



Terminal No.	Color of Wire	Signal Name [Specification]
2	R	-
3	L	-
4	G	-
5	LG	-
6	V	-
7	BG	-
8	V	-
9	L	-
10	Y	-
11	V	-
12	V	-
18	G	-
19	Y	-
20	BR	-
21	GR	-
22	BG	-
23	GR	-
24	G	-

A
B
C
D
E
F
G
H
I
J
K
L
PG
N
O
P

CONNECTOR INFORMATION

< WIRING DIAGRAM >

MAIN HARNESS

Connector No.	M18
Connector Name	TRUNK LID OPENER CANCEL SWITCH
Connector Type	502FW



Terminal No.	Color of Wire	Signal Name [Specification]
1	V	-
2	B	-

Connector No.	M20
Connector Name	POB HARNESS
Connector Type	TH40FB-NH



Terminal No.	Color of Wire	Signal Name [Specification]
1	B	-
11	BR	-
12	R	-
14	L	-
15	B	-
17	R	-
19	W	-
20	R	-
21	B	-
22	R	-
23	L	-
24	L	-
27	Y	- [With 4WAS]
27	P	- [Without 4WAS]
28	SB	-
31	V	-
33	V	-
36	L	-
36	P	-
38	L	-

40	Y	-
----	---	---

Connector No.	M21
Connector Name	POB HARNESS
Connector Type	TH40FW-NH



Terminal No.	Color of Wire	Signal Name [Specification]
41	LG	-
42	SHIELD	-
43	Y	- [With BOSE system]
43	V	- [Without BOSE system]
44	BR	- [With BOSE system]
44	P	- [Without BOSE system]
45	SHIELD	-
46	SB	- [With BOSE system]
46	G	- [Without BOSE system]
47	V	- [With BOSE system]
47	GR	- [Without BOSE system]
48	SHIELD	-
49	R	-
50	G	- [With BOSE system]
50	BR	- [Without BOSE system]
51	SHIELD	-
52	P	- [With BOSE system]
52	L	- [Without BOSE system]
53	L	- [With BOSE system]
53	G	- [Without BOSE system]
54	SB	- [With 4WAS]
54	Y	- [Without 4WAS]
55	BR	-
56	G	-
57	R	-
61	SB	-
62	SB	-
63	LG	-
64	B	-
65	L	-
66	R	-
67	SHIELD	-
69	V	-
71	Y	-
72	B	-

73	W	-
74	R	-
75	G	-

Connector No.	M22
Connector Name	POB HARNESS
Connector Type	TH40FB-NH



Terminal No.	Color of Wire	Signal Name [Specification]
81	L	-
82	P	-
84	B	-
85	B	-
86	B	-
87	B	-
88	B	-
89	Y	-
91	V	-
92	V	-
93	B	-
94	LG	-
95	LG	-
96	BR	-
97	G	-
98	G	-
99	G	-
100	G	-
101	L	-
102	P	-
103	B	-
104	BR	-
105	R	-
107	Y	-
108	Y	-
109	BR	-
110	Y	-
112	B	-
113	P	-
114	L	-
116	B	-
117	B	- [With VK engine]
117	BG	- [With VQ engine]

118	B	-
119	G	-
120	V	-

Connector No.	M23
Connector Name	POB HARNESS
Connector Type	TH40FW-NH



Terminal No.	Color of Wire	Signal Name [Specification]
121	R	-
122	V	-
123	5G	-
124	BG	-
128	BR	-
130	B	-
131	SB	-
132	LG	-
133	L	-
135	P	-
137	Y	-
138	L	-
139	P	-
140	L	-
141	W	-
142	W	-
144	P	-
145	B	-
146	B	-
147	B	-
148	L	-
149	B	-
150	P	-
151	L	-
152	B	-
153	W	-
154	W	-
155	W	-
157	W	-
158	R	-
159	R	-

CONNECTOR INFORMATION

< WIRING DIAGRAM >

MAIN HARNESS

Connector No.	M24
Connector Name	PCB HARNESS
Connector Type	TH40FW-NH



Terminal No.	Color of Wire	Signal Name [Specification]
161	BG	-
162	BG	-
163	G	- [With BOSE system]
164	V	- [Without BOSE system]
165	V	- [Without BOSE system]
166	R	-
167	LG	-
168	R	-
169	R	-
170	B	-
172	B	-
174	W	-
175	B	-
176	L	-
177	P	-
178	Y	-
179	L	-
180	LG	-
182	BR	-
183	G	-
184	V	-
185	P	- [With BOSE system]
185	V	- [Without BOSE system]
186	R	-
187	L	-
188	Y	-
189	B	-
190	V	-
191	G	-
192	B	-
193	SB	-
194	BR	-
198	R	-
199	B	-
200	SB	-

Connector No.	M25
Connector Name	PCB HARNESS
Connector Type	TH40FB-NH

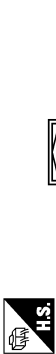

Terminal No.	Color of Wire	Signal Name [Specification]
201	L	-
208	G	-
209	L	- [With BOSE system]
209	G	- [Without BOSE system]
210	P	- [Without BOSE system]
210	L	- [Without BOSE system]
211	SHIELD	-
212	G	- [With BOSE system]
212	BR	- [Without BOSE system]
213	R	-
214	SHIELD	-
215	V	- [With BOSE system]
215	GR	- [Without BOSE system]
216	LG	- [With BOSE system]
216	G	- [Without BOSE system]
217	SHIELD	-
218	BR	- [With BOSE system]
218	P	- [Without BOSE system]
219	GR	- [With BOSE system]
219	V	- [Without BOSE system]
220	SHIELD	-
221	P	-
222	LG	-
223	SB	-
224	SB	-
225	LG	-
226	R	-
230	BR	-
231	SB	-
232	V	-
233	L	-
234	P	-
235	B	-
240	W	-

Connector No.	M26
Connector Name	PCB HARNESS
Connector Type	TH40FW-NH



Terminal No.	Color of Wire	Signal Name [Specification]
241	L	-
242	L	-
243	R	-
244	L	-
245	B	-
246	B	-
247	Y	-
248	W	-
253	B	-
254	W	- [With climate controlled seat]
254	W	- [Without climate controlled seat]
255	B	-
258	R	-
259	L	-
260	BG	-
261	P	-
262	P	-
269	GR	-
270	Y	-
271	BR	-
272	G	-
273	R	-
274	R	-
275	Y	-
276	SB	- [With 4WAS]
276	B	- [Without 4WAS]
277	G	- [Except for Federal with 2WMI sport advanced technology]
277	Y	- [For Federal with 2WMI sport advanced technology]
278	R	-
279	R	-
280	Y	-

Connector No.	M27
Connector Name	PCB HARNESS
Connector Type	TH40FB-NH



Terminal No.	Color of Wire	Signal Name [Specification]
281	O	-
282	BG	-
283	BG	-
284	BG	-
286	W	-
287	Y	-
288	W	-
289	SHIELD	-
290	B	-
291	SHIELD	-
292	B	-
293	B	-
294	B	-
295	B	-
297	B	-
298	B	-
299	V	-
300	W	-
301	R	-
302	R	-
303	R	-
306	V	-
307	LG	-
308	SB	-
309	G	-
310	R	-
311	W	-
312	Y	- [With 4WAS]
312	B	- [Without 4WAS]
313	SB	- [With 4WAS]
313	B	- [Without 4WAS]
319	V	-
320	W	-

A
B
C
D
E
F
G
H
I
J
K
L
PG
N
O
P

CONNECTOR INFORMATION

< WIRING DIAGRAM >

MAIN HARNESS

Connector No.	M28
Connector Name	POB HARNESS
Connector Type	TH40FW-NH

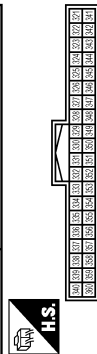

Connector No.	M29
Connector Name	PCB HARNESS
Connector Type	TH40FS-NH

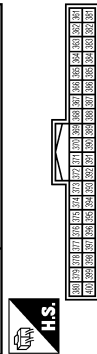

Terminal No.	Color of Wire	Signal Name [Specification]
321	V	-
322	V	-
324	B	-
325	L	-
326	L	-
327	P	-
328	P	-
330	B	-
331	V	-
332	V	-
335	B	-
337	W	-
338	W	-
343	L	-
344	B	-
345	Y	-
346	L	-
347	P	-
348	GR	-
349	V	-
350	LG	-
351	P	-
352	R	-
353	P	-
358	W	-
359	W	-
360	G	-

Terminal No.	Color of Wire	Signal Name [Specification]
361	W	-
362	W	-
363	Y	-
366	B	-
367	B	-
368	G	-
373	BR	-
374	BG	-
375	BG	-
376	V	-
377	V	-
378	B	-
379	R	-
380	R	-
381	G	-
382	V	-
383	GR	-
384	GR	-
395	P	-
396	L	-
397	R	-
398	L	-
400	V	-

Connector No.	M30
Connector Name	PCB HARNESS
Connector Type	TH40FW-NH



Terminal No.	Color of Wire	Signal Name [Specification]
402	R	-
403	R	-
407	V	-
408	B	-
409	B	-
410	B	-
411	B	-
413	Y	-
414	BR	-
416	V	- [With 10 speaker]
416	LG	- [Without 10 speaker]
417	B	-
419	SB	-
420	SHIELD	-
422	V	-
427	P	-
428	V	-
429	P	-
430	LG	-
431	B	-
432	Y	-
435	V	-
438	BG	-
437	B	-
438	P	-
439	L	-
440	B	-

Connector No.	M31
Connector Name	TILT & TELESCOPIC SWITCH
Connector Type	TK40FGY

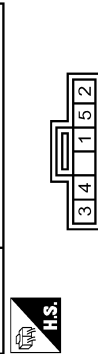

Terminal No.	Color of Wire	Signal Name [Specification]
1	B	GND
2	W	TELESCOPIC FR
3	G	TELESCOPIC RR
4	Y	TILT UP
5	SB	TILT DOWN

Connector No.	M32
Connector Name	PADDLE SHIFTER (SHIFT-DOWN)
Connector Type	JA33FW

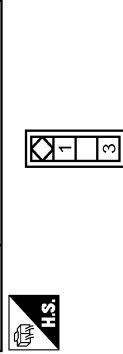

Terminal No.	Color of Wire	Signal Name [Specification]
1	B	-
3	G	-

Connector No.	M33
Connector Name	COMBINATION SWITCH
Connector Type	TH16FW-NH

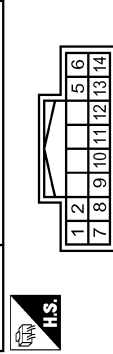

Terminal No.	Color of Wire	Signal Name [Specification]
1	W	FR WASHER (-)
2	SB	OUTPUT 4
5	L	OUTPUT 3
6	B	GND
7	V	INPUT 3
8	BG	OUTPUT 5
9	Y	INPUT 2
10	R	INPUT 4
11	LG	INPUT 1
12	P	OUTPUT 1
13	BR	INPUT 5
14	G	OUTPUT 2

CONNECTOR INFORMATION

< WIRING DIAGRAM >

MAIN HARNESS

Connector No.	M35
Connector Name	COMBINATION SWITCH (SPIRAL CABLE)
Connector Type	TK08FY-EX-1V



Terminal No.	Color of Wire	Signal Name [Specification]
23	R	-
28	Y	-
29	Y	-
30	Y	-

Connector No.	M38
Connector Name	COMBINATION SWITCH (SPIRAL CABLE)
Connector Type	TK08FGY-1V

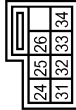

Terminal No.	Color of Wire	Signal Name [Specification]
24	P	-
25	SB	-
26	B	-
31	L	-
32	Y	-
33	B	-
34	LG	-

Connector No.	M37
Connector Name	STEERING ANGLE SENSOR
Connector Type	TH08FY-NH

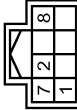

Terminal No.	Color of Wire	Signal Name [Specification]
1	L	CAN-H
2	P	CAN-L
7	B	GND
8	G	IGN

Connector No.	M39
Connector Name	PAIDLE SHIFTER (SHIFT-UP)
Connector Type	A04FW



Terminal No.	Color of Wire	Signal Name [Specification]
1	B	-
3	BG	-

Connector No.	M41
Connector Name	4WAS FRONT CONTROL UNIT
Connector Type	SNM0ZFGY



Terminal No.	Color of Wire	Signal Name [Specification]

11	R	FR-MTR_PWR_SUPPLY
12	B	FR-MTR_GND

Connector No.	M42
Connector Name	4WAS FRONT CONTROL UNIT
Connector Type	TKZ2FW

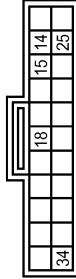

Terminal No.	Color of Wire	Signal Name [Specification]
14	R	4WAS_COMMUNICATION-L
15	W	IGN
18	B	GND
23	L	4WAS_COMMUNICATION-H
34	B	GND

Connector No.	M43
Connector Name	LOW TIRE PRESSURE WARNING CONTROL UNIT
Connector Type	TH02FW-NH



Terminal No.	Color of Wire	Signal Name [Specification]
1	P	CAN-L
2	L	CAN-H
3	B	RR_TUNER (SIG)
4	B	RL_TUNER (SIG)
5	B	FR_TUNER (SIG)
6	G	FL_TUNER (SIG)
7	R	RR_TUNER (VCC)
8	W	RL_TUNER (VCC)
9	W	FR_TUNER (VCC)
10	W	FL_TUNER (VCC)
19	Y	IGN
20	G	RR_TUNER (RSSI)
		RL_TUNER (RSSI)

21	G	FR_TUNER (RSSI)
22	R	EL_TUNER (RSSI)
23	W	RR_TUNER (GND)
24	R	RL_TUNER (GND)
25	R	FR_TUNER (GND)
26	B	FL_TUNER (GND)
30	G	BCM_FLASHER
32	B	GND

Connector No.	M45
Connector Name	WARNING BUZZER
Connector Type	INS04FER-GS



Terminal No.	Color of Wire	Signal Name [Specification]
1	G	-
2	W	-
3	B	-

Connector No.	M46
Connector Name	SUNLOAD SENSOR
Connector Type	TC03FW



Terminal No.	Color of Wire	Signal Name [Specification]
1	L	LH_SIG
2	P	RH_SIG
3	W	PWR

JRMWC9577GB

A B C D E F G H I J K L N O P

PG

CONNECTOR INFORMATION

< WIRING DIAGRAM >

MAIN HARNESS

Connector No.	M47
Connector Name	SOMAR CONTROL UNIT
Connector Type	TH24FW-NH

Connector No.	M49
Connector Name	TELESCOPIIC MOTOR
Connector Type	NS58FW-CS

Connector No.	M51
Connector Name	AUTOMATIC DRIVE POSITIONER CONTROL UNIT
Connector Type	TH24FW-NH

Terminal No.	Color of Wire	Signal Name [Specification]
1	LG	IGN
2	SB	CANCEL SW
5	W	CORNER SENSOR REAR LH
6	B	CORNER SENSOR REAR RH
7	G	CENTER SENSOR REAR LH
8	R	CENTER SENSOR REAR RH
11	B	CANCEL SW INDICATOR
12	B	SENSOR GND
13	L	ACC
17	BG	REVERSE
18	V	K-LINE
19	SB	AV COMM (H)
20	LG	AV COMM (L)
24	B	GND

Connector No.	M48
Connector Name	TILT MOTOR
Connector Type	NS58FW-CS

Terminal No.	Color of Wire	Signal Name [Specification]
1	L	-
2	LG	-
4	P	-
5	R	-
6	BR	-

Connector No.	M50
Connector Name	PUSH-BUTTON IGNITION SWITCH
Connector Type	TK08FBF

Terminal No.	Color of Wire	Signal Name [Specification]
1	B	-
2	B	-
3	R	-
4	BR	-
5	GR	-
6	Y	-
7	V	-
8	W	-

Terminal No.	Color of Wire	Signal Name [Specification]
25	W	BAT (C/B)
26	L	TELESCOPIC MOTOR (BACKWARD)
27	P	POWER SUPPLY (SENSOR)
28	G	TILT MOTOR (DOWNWARD)
29	LG	TILT MOTOR (UPWARD)
30	B	GND

Terminal No.	Color of Wire	Signal Name [Specification]
1	Y	TILT SW (UPWARD)
2	V	MIRROR SELECT SW (RH)
3	Y	MIRROR SW (UPWARD)
4	V	MIRROR SW (LEFTWARD)
5	BR	MIRROR SENSOR (RH VERTICAL)
6	BR	MIRROR SENSOR (LH VERTICAL)
7	W	TELESCOPIC SW (FRONTWARD)
8	LG	Rc/Tx
10	BR	MIRROR MOTOR (RH VERTICAL)
11	L	MIRROR MOTOR (RH HORIZONTAL)
12	G	MIRROR MOTOR (LH COMMON)
13	SB	TILT SW (DOWNWARD)
14	O	MIRROR SELECT SW (LH)
15	L	MIRROR SW (DOWNWARD)
16	V	MIRROR SW (RIGHTWARD)
17	G	MIRROR SENSOR (RH HORIZONTAL)
18	G	MIRROR SENSOR (LH HORIZONTAL)
19	G	TELESCOPIC SW (BACKWARD)
20	Y	GND (SENSOR)
21	GR	POWER SUPPLY (SENSOR)
22	Y	MIRROR MOTOR (RH COMMON)
23	O	MIRROR MOTOR (LH VERTICAL)
24	GR	MIRROR MOTOR (LH HORIZONTAL)

Connector No.	M52
Connector Name	AUTOMATIC DRIVE POSITIONER CONTROL UNIT
Connector Type	NS58FW-CS

JRMWC9578GB

CONNECTOR INFORMATION

< WIRING DIAGRAM >

MAIN HARNESS

Connector No.	M55
Connector Name	COMBINATION METER
Connector Type	TH10FW-NH



Terminal No.	Color of Wire	Signal Name [Specification]
1	W	BATTERY POWER SUPPLY
2	BG	IGNITION SIGNAL
3	GR	VEHICLE SPEED SIGNAL (2-PULSE)
4	R	VEHICLE SPEED SIGNAL (8-PULSE)
5	B	ILLUMINATION CONTROL SIGNAL
6	B	METER CONTROL SWITCH GROUND
7	SB	METER SWITCH SIGNAL
8	LG	SELECT SWITCH SIGNAL
9	G	ILLUMINATION CONTROL SWITCH SIGNAL (+)
10	GR	ILLUMINATION CONTROL SWITCH SIGNAL (-)
11	L	TRIP RESET SWITCH SIGNAL
12	B	GROUND
14	L	CAN-H
15	P	CAN-L
16	R	AIR BAG SIGNAL
23	B	GROUND
24	B	FUEL LEVEL SENSOR GROUND
25	W	ALTERNATOR SIGNAL
26	V	PARKING BRAKE SWITCH SIGNAL
27	V	BRAKE FLUID LEVEL SWITCH SIGNAL
28	G	SECURITY SIGNAL
29	L	WASHER LEVEL SWITCH SIGNAL
32	G	PADDLE SHIFTER SHIFT DOWN SIGNAL
33	BG	PADDLE SHIFTER SHIFT UP SIGNAL
34	G	FUEL LEVEL SENSOR SIGNAL
36	W	SEAT BELT BUCKLE SWITCH SIGNAL (DRIVER SIDE)
36	G	PASSENGER SEAT BELT WARNING SIGNAL
37	G	NON-MANUAL MODE SIGNAL
38	V	MANUAL MODE SHIFT DOWN SIGNAL
39	L	MANUAL MODE SHIFT UP SIGNAL
40	W	MANUAL MODE SIGNAL

Connector No.	M54
Connector Name	METER CONTROL SWITCH
Connector Type	TH12MW-NH

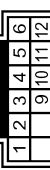

Terminal No.	Color of Wire	Signal Name [Specification]
1	SB	-
2	B	-
3	GR	-
4	R	-
5	W	-
6	G	-
9	BG	-
10	GR	-
11	LG	-
12	L	-

Connector No.	M61
Connector Name	CLIMATE CONTROLLED SEAT RELAY
Connector Type	M08FBR-R-LC



Terminal No.	Color of Wire	Signal Name [Specification]
1	B	-
2	W	-
3	W	-
5	LG	-
6	G	-
7	SB	-

Connector No.	M63
Connector Name	CENTER SPEAKER
Connector Type	TK02FBR



Terminal No.	Color of Wire	Signal Name [Specification]
1	V	-
2	P	-

Connector No.	M65
Connector Name	CIRCUIT BREAKER
Connector Type	M02FW-LC



Terminal No.	Color of Wire	Signal Name [Specification]
1	W	-
2	W	-

Connector No.	M66
Connector Name	A/C AUTO AMP.
Connector Type	TH20FW-T66



Terminal No.	Color of Wire	Signal Name [Specification]
1	L	BATTERY POWER SUPPLY
2	W	IGNITION POWER SUPPLY

6	R	BLOWER MOTOR F/B SIGNAL
7	L	POWER TRANSISTOR CONTROL SIGNAL
10	B	GROUND
11	P	CAN-L
12	L	CAN-H
13	V	ACC POWER SUPPLY
17	BG	ECV CONTROL SIGNAL
20	R	HUMIDITY SENSOR (SOCK) SIGNAL
21	Y	HUMIDITY SENSOR (DATA) SIGNAL
22	B	HUMIDITY SENSOR GROUND
23	W	DRIVE MODE SELECT SW (SNOW)
24	L	DRIVE MODE SELECT SW (ECO)
25	G	DRIVE MODE SELECT SW (STANDARD)
26	Y	DRIVE MODE SELECT SW (SPORT)

Connector No.	M67
Connector Name	A/C AUTO AMP.
Connector Type	TH24FW-NH

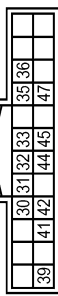

Terminal No.	Color of Wire	Signal Name [Specification]
30	L	EVN GAS / OUTSIDE DOOR DETECTING SENSOR SIGNAL
31	BG	AMBIENT SENSOR SIGNAL
32	LG	IN-VEHICLE SENSOR SIGNAL
33	LG	HUMIDITY SENSOR (WINDOW TEMPERATURE) SIGNAL
35	L	SUNLOAD SENSOR (DR) SIGNAL
36	V	INSIDE DOOR DETECTING SENSOR SIGNAL
39	W	SENSOR POWER SUPPLY
41	L	HEATED STEERING WHEEL RELAY CONTROL SIGNAL
42	W	IONIZER CONTROL SIGNAL
44	B	GROUND
45	G	HEATED STEERING WHEEL SWITCH SIGNAL
47	P	SUNLOAD SENSOR (PASS) SIGNAL

A B C D E F G H I J K L N O P

PG

JRMWC9579GB

CONNECTOR INFORMATION

< WIRING DIAGRAM >

MAIN HARNESS

Connector No.	M68
Connector Name	HEATED STEERING WHEEL RELAY
Connector Type	MS02FL-M2-LC

Terminal No.	Color of Wire	Signal Name [Specification]
1	B	-
2	L	-
3	B	-
5	BR	-

Connector No.	M69
Connector Name	BACK-UP LAMP RELAY
Connector Type	MS02FL-M2-LC

Terminal No.	Color of Wire	Signal Name [Specification]
1	LG	-
2	R	-
3	BR	-
5	BG	-

Connector No.	M70
Connector Name	HEATED SEAT RELAY
Connector Type	MS02FL-M2-LC

Terminal No.	Color of Wire	Signal Name [Specification]
1	B	-
2	W	-
3	G	-
5	SB	-

Connector No.	M71
Connector Name	HEATED STEERING WHEEL
Connector Type	NS02FW-CS

Terminal No.	Color of Wire	Signal Name [Specification]
1	BR	-
2	B	-

Connector No.	M72
Connector Name	MULTIFUNCTION SWITCH
Connector Type	TH06FW-NH

Terminal No.	Color of Wire	Signal Name [Specification]
1	B	GND
3	V	ACC
4	R	ILL
5	B	ILL CONT
6	SB	AV COMM (H)
8	LG	AV COMM (L)
9	BR	SW GND
14	SB	DISK EJECT SIGNAL
15	R	AIR BAG CUT OFF
16	G	HAZARD ON

Connector No.	M73
Connector Name	INSIDE ODOR DETECTING SENSOR
Connector Type	TH06FW-NH

Terminal No.	Color of Wire	Signal Name [Specification]
1	V	SENS SIG
2	B	SENS GRD
3	B	GND
4	LG	IGN

Connector No.	M74
Connector Name	CLOCK
Connector Type	TH06FW-NH

Terminal No.	Color of Wire	Signal Name [Specification]
1	W	BATTERY POWER SUPPLY
2	B	GROUND
3	R	ILLUMINATION (+)
4	B	ILLUMINATION (-)

JRMWC9580GB

CONNECTOR INFORMATION

< WIRING DIAGRAM >

MAIN HARNESS

Connector No.	M77
Connector Name	WIRE TO WIRE
Connector Type	TH10MW-NH



1	2	3	4	5	6	7	8	9	10	11	12	13	14	15	16	17	18	19	20	

Terminal No.	Color of Wire	Signal Name [Specification]
3	SHIELD	-
4	Y	-
5	G	-
6	R	-
7	W	-
8	B	-
9	LG	-
10	SB	-
11	LG	-
12	SB	-
13	B	-
14	P	- [With BOSE system]
14	V	- [Without BOSE system]
15	LG	-
16	L	-
17	G	-
18	R	-
19	V	-
20	V	-
21	B	-
22	B	-
23	B	-
29	SHIELD	-
30	Y	- [With BOSE system]
30	BR	- [Without BOSE system]
31	P	- [With BOSE system]
31	SHIELD	- [Without BOSE system]
32	SHIELD	-
33	SB	- [With BOSE system]
33	G	- [Without BOSE system]
34	V	- [With BOSE system]
34	GR	- [Without BOSE system]
35	SHIELD	-
36	R	-
37	G	- [With BOSE system]
37	BR	- [Without BOSE system]
38	SHIELD	-
38	P	- [With BOSE system]

39	L	- [Without BOSE system]
40	L	- [With BOSE system]
40	G	- [Without BOSE system]

Connector No.	M81
Connector Name	AV CONTROL UNIT
Connector Type	TH18FW-GS2



1	2	3	4	5	6	7	8	9	10
19	11	12	13	14	15	16	17	18	20

Terminal No.	Color of Wire	Signal Name [Specification]
2	G	SOUND SIGNAL FRONT LH (+)
3	L	SOUND SIGNAL FRONT LH (-)
4	GR	SOUND SIGNAL REAR LH (+)
5	G	SOUND SIGNAL REAR LH (-)
6	P	STRG SW A
7	V	ACC
9	SB	ILLUMINATION
11	BR	SOUND SIGNAL FRONT RH (+)
12	R	SOUND SIGNAL FRONT RH (-)
13	P	SOUND SIGNAL REAR RH (+)
14	V	SOUND SIGNAL REAR RH (-)
15	B	STRG SW GND
16	L	STRG SW B
19	Y	BATTERY
20	B	GND

Connector No.	M82
Connector Name	AV CONTROL UNIT
Connector Type	TH24FW-NH



36	37	38	39	40	41	42	43	44	45	46	47
48	49	50	51	52	53	54	55	56	57	58	

Terminal No.	Color of Wire	Signal Name [Specification]
36	BR	SIGNAL VCC
37	B	SIGNAL GND

38	G	HP
39	Y	COMM (DSP->CONT)
40	R	RGB AREA (VS) SIGNAL
41	SHIELD	SHIELD
42	W	RGB SYNC
43	R	RGB (RED) SIGNAL
44	B	RGB (GREEN) SIGNAL
45	W	RGB (BLUE) SIGNAL
46	V	COMPOSITE IMAGE GND
47	SB	COMPOSITE IMAGE SIGNAL
48	L	INVERTER VCC
49	LG	INVERTER GND
50	B	VP
51	BR	COMM (CONT->DISP)
52	SHIELD	SHIELD
57	SHIELD	SHIELD

Connector No.	M83
Connector Name	AV CONTROL UNIT
Connector Type	TH18FW-NH



62	71	72	73
----	----	----	----

Terminal No.	Color of Wire	Signal Name [Specification]
62	W	CAMERA IMAGE SIGNAL
71	SHIELD	SHIELD
72	B	CAMERA GND
73	W	CAMERA POWER SUPPLY

Connector No.	M84
Connector Name	AV CONTROL UNIT
Connector Type	TH32FW-NH



76	77	78	79	80	81	82
92	93	94	95	96	97	98

Terminal No.	Color of Wire	Signal Name [Specification]
76	LG	AV COMM (L)
77	SB	AV COMM (H)
78	SB	AV COMM (H)
79	LG	AV COMM (L)
80	P	CAN-L
81	L	CAN-H
82	BR	SW GND
86	SHIELD	SHIELD
87	P	TEL VOICE SIGNAL (+)
88	L	TEL VOICE SIGNAL (-)
92	R	VEHICLE SPEED (8-PULSE)
93	V	PARKING BRAKE
94	EG	REVERSE
95	W	IGNITION
96	SB	DISK EJECT SIGNAL

Connector No.	M85
Connector Name	AV CONTROL UNIT
Connector Type	JA2FW



121	121	122
124	125	126
127	127	130

Terminal No.	Color of Wire	Signal Name [Specification]
120	B	SATELLITE RADIO SOUND SIGNAL LH (+)
121	G	SATELLITE RADIO SOUND SIGNAL RH (+)
122	O	COMM (CONT->SAT)
124	W	SATELLITE RADIO SOUND SIGNAL LH (-)
125	R	SATELLITE RADIO SOUND SIGNAL RH (-)
126	SHIELD	SHIELD
127	SHIELD	SHIELD
128	Y	REQUEST (SAT->CONT)
130	BR	COMM (SAT->CONT)

A B C D E F G H I J K L N O P PG

CONNECTOR INFORMATION

< WIRING DIAGRAM >

MAIN HARNESS

Connector No.	M86	Connector No.	M81	Connector No.	M84	Connector No.	M101
Connector Name	AV CONTROL UNIT	Connector Name	WIRE TO WIRE	Connector Name	OPTICAL SENSOR	Connector Name	PASSENGER AIR BAG MODULE
Connector Type	HAADGFL	Connector Type	TK02FBR	Connector Type	TK03FW	Connector Type	TK04FY-BD
Terminal No.	132	Terminal No.	1	Terminal No.	1	Terminal No.	1
Color of Wire	G	Color of Wire	B	Color of Wire	Y	Color of Wire	Y
Signal Name [Specification]	USB GND	Signal Name [Specification]	—	Signal Name [Specification]	POWER	Signal Name [Specification]	—
Terminal No.	133	Terminal No.	2	Terminal No.	2	Terminal No.	2
Color of Wire	W	Color of Wire	R	Color of Wire	W	Color of Wire	Y
Signal Name [Specification]	V BUS SIGNAL	Signal Name [Specification]	—	Signal Name [Specification]	OUTPUT	Signal Name [Specification]	—
Terminal No.	134	Terminal No.	3	Terminal No.	3	Terminal No.	3
Color of Wire	R	Color of Wire	B	Color of Wire	B	Color of Wire	Y
Signal Name [Specification]	USE D- SIGNAL	Signal Name [Specification]	—	Signal Name [Specification]	GND	Signal Name [Specification]	—
Terminal No.	135	Terminal No.	4	Terminal No.	4	Terminal No.	4
Color of Wire	L	Color of Wire	—	Color of Wire	—	Color of Wire	Y
Signal Name [Specification]	USE D+ SIGNAL	Signal Name [Specification]	—	Signal Name [Specification]	—	Signal Name [Specification]	—
Terminal No.	136	Terminal No.	5	Terminal No.	10	Terminal No.	10
Color of Wire	SHIELD	Color of Wire	SHIELD	Color of Wire	L	Color of Wire	L
Signal Name [Specification]	SHIELD	Signal Name [Specification]	SHIELD	Signal Name [Specification]	—	Signal Name [Specification]	—
Terminal No.	136	Terminal No.	11	Terminal No.	11	Terminal No.	11
Color of Wire	—	Color of Wire	—	Color of Wire	P	Color of Wire	P
Signal Name [Specification]	—	Signal Name [Specification]	—	Signal Name [Specification]	—	Signal Name [Specification]	—
Terminal No.	—	Terminal No.	12	Terminal No.	12	Terminal No.	12
Color of Wire	—	Color of Wire	—	Color of Wire	SHIELD	Color of Wire	SHIELD
Signal Name [Specification]	—	Signal Name [Specification]	—	Signal Name [Specification]	—	Signal Name [Specification]	—
Connector No.	M80	Connector No.	M92	Connector No.	M88	Connector No.	M104
Connector Name	USB CONNECTOR	Connector Name	WIRE TO WIRE	Connector Name	IONIZER	Connector Name	REMOTE KEYLESS ENTRY RECEIVER
Connector Type	HAADDFG	Connector Type	TK02MBR-P	Connector Type	TH03FY-NH	Connector Type	TH04FW-NH
Terminal No.	1	Terminal No.	1	Terminal No.	1	Terminal No.	1
Color of Wire	W	Color of Wire	B	Color of Wire	P	Color of Wire	B
Signal Name [Specification]	—	Signal Name [Specification]	—	Signal Name [Specification]	IGN	Signal Name [Specification]	—
Terminal No.	2	Terminal No.	2	Terminal No.	2	Terminal No.	2
Color of Wire	L	Color of Wire	R	Color of Wire	R	Color of Wire	BR
Signal Name [Specification]	—	Signal Name [Specification]	—	Signal Name [Specification]	GND	Signal Name [Specification]	SIGNAL OUTPUT
Terminal No.	3	Terminal No.	3	Terminal No.	3	Terminal No.	3
Color of Wire	G	Color of Wire	—	Color of Wire	—	Color of Wire	GR
Signal Name [Specification]	—	Signal Name [Specification]	—	Signal Name [Specification]	—	Signal Name [Specification]	RSSI
Terminal No.	4	Terminal No.	4	Terminal No.	4	Terminal No.	4
Color of Wire	R	Color of Wire	—	Color of Wire	W	Color of Wire	R
Signal Name [Specification]	—	Signal Name [Specification]	—	Signal Name [Specification]	ION ON / OFF	Signal Name [Specification]	BATTERY
Terminal No.	5	Terminal No.	5	Terminal No.	4	Terminal No.	4
Color of Wire	SHIELD	Color of Wire	—	Color of Wire	—	Color of Wire	—
Signal Name [Specification]	—	Signal Name [Specification]	—	Signal Name [Specification]	—	Signal Name [Specification]	—

JRMWC9582.GB

CONNECTOR INFORMATION

< WIRING DIAGRAM >

MAIN HARNESS

Connector No.	M105
Connector Name	WIRE TO WIRE
Connector Type	TH14UFW-NH

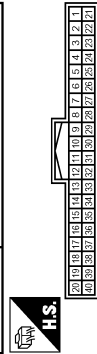

Terminal No.	Color of Wire	Signal Name [Specification]
1	R	-
2	B	-
3	B	-
4	LG	-
5	P	-
6	P	-
7	L	-
8	P	-
9	B	-
10	W	-
11	W	-
12	SB	-
14	SB	-
15	BR	-
16	V	-
18	G	-
19	B	-
20	V	-
22	BG	-
23	B	-
25	W	-
27	SB	-
29	B	-
30	R	-
31	BR	-
32	L	-
33	P	-
34	LG	-
35	W	-
36	LG	-
37	L	-
38	R	-

Connector No.	M106
Connector Name	WIRE TO WIRE
Connector Type	INSB8MW-CS

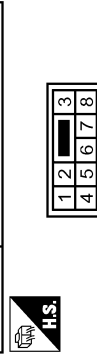

Terminal No.	Color of Wire	Signal Name [Specification]
1	B	-
3	R	-
4	BG	-
5	Y	-
6	R	-
7	B	-
8	L	-

Connector No.	M107
Connector Name	ECM
Connector Type	RH24F3Y-RZ8-R-RH-Z

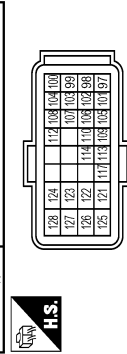

Terminal No.	Color of Wire	Signal Name [Specification]
97	R	ACCELERATOR PEDAL POSITION SENSOR 1
98	Y	ACCELERATOR PEDAL POSITION SENSOR 2
99	G	SENSOR POWER SUPPLY / ACCELERATOR PEDAL POSITION SENSOR 1
100	W	SENSOR GROUND / ACCELERATOR PEDAL POSITION SENSOR 1
101	SB	ASC2 STEERING SWITCH
102	P	FUEL TANK PRESSURE SENSOR
103	L	SENSOR POWER SUPPLY / ACCELERATOR PEDAL POSITION SENSOR 2
104	BR	SENSOR GROUND [With ICC]
105	LG	REFRIGERANT PRESSURE SENSOR
106	P	FUEL TANK TEMPERATURE SENSOR
107	BG	AVCC2 POPRES / FTPRES
108	Y	GND ASC2 SW
109	BR	TRANSMISSION RANGE SWITCH
110	V	ENGINE SPEED SIGNAL OUTPUT

112	V	GND4 POPRES / FTPRES
113	P	CAN COMMUNICATION LINE
114	L	CAN COMMUNICATION LINE
117	V	DATA LINK CONNECTOR
121	G	E/VAP CANISTER VENT CONTROL VALVE
122	P	STOP LAMP SWITCH
123	B	ECM GROUND
124	B	ECM GROUND
125	SB	POWER SUPPLY FOR ECM
126	BR	ASC2 BRAKE SWITCH
127	B	ECM GROUND
128	B	ECM GROUND

Connector No.	M108
Connector Name	POWER STEERING CONTROL UNIT
Connector Type	TH12FW-NH

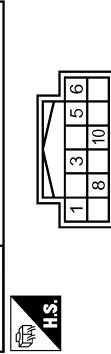

Terminal No.	Color of Wire	Signal Name [Specification]
1	LG	EPS SOL+
3	G	IGN
5	B	EPS SOL-
6	B	GND
8	GR	VEHICLE SPEED (2P)
10	V	ENG TACHO

Connector No.	M109
Connector Name	BLOWER MOTOR
Connector Type	SNM2FW

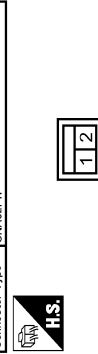

Terminal No.	Color of Wire	Signal Name [Specification]
1	Y	-
2	R	-

Connector No.	M110
Connector Name	WIRE TO WIRE
Connector Type	TH24MWF-NH



Terminal No.	Color of Wire	Signal Name [Specification]
1	G	-
2	Y	-
3	W	-
4	R	-
7	BR	-
8	R	-
9	B	-
10	V	-
11	BR	-
12	G	-
13	L	-
14	B	-
15	LG	-
16	Y	-
17	W	-
18	R	-
19	B	-
20	V	-
21	R	-
22	G	-
23	L	-
24	LG	-

A B C D E F G H I J K L N O P

PG

JRMWC9583GB

CONNECTOR INFORMATION

< WIRING DIAGRAM >

MAIN HARNESS

Connector No.	M112
Connector Name	POWER TRANSISTOR
Connector Type	SLB03FW-SMA2

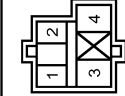

Terminal No.	Color of Wire	Signal Name [Specification]
1	R	FAN F/B
2	L	FANOUT
3	R	SIG
4	B	GND

Connector No.	M114
Connector Name	FOOT LAMP (PASSENGER SIDE)
Connector Type	C05FW

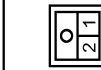

Terminal No.	Color of Wire	Signal Name [Specification]
1	R	-
2	BR	-

Connector No.	M116
Connector Name	WIRE TO WIRE
Connector Type	TKS8MW-MS10

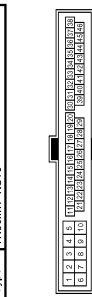

Terminal No.	Color of Wire	Signal Name [Specification]
1	R	-
2	BR	-

2	SB	-
3	Y	-
4	B	- [With VK engine]
4	SB	- [With VQ engine]
5	B	-
7	W	-
8	Y	-
9	W	- [With VK engine]
9	SB	- [With VQ engine]
10	SB	-
11	L	-
12	P	-
13	V	-
14	R	-
15	Y	-
16	SB	-
17	BR	-
18	LG	-
21	LG	-
22	B	-
23	W	-
24	W	-
25	BG	-

Connector No.	M117
Connector Name	WIRE TO WIRE
Connector Type	TH80FW-CS16-TM4

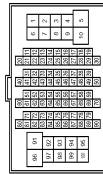

Terminal No.	Color of Wire	Signal Name [Specification]
3	Y	-
8	R	-
13	W	-
17	GR	-
18	P	-
19	BR	-
20	GR	-
21	Y	-
22	LG	-
23	P	-
24	BG	-
25	BG	-
26	W	-

96	W	-
97	Y	-
98	BR	-
99	G	-
100	Y	-

27	R	-
28	V	-
29	P	-
30	B	-
31	G	-
32	Y	-
40	SHIELD	-
41	R	-
42	V	-
44	W	-
45	SB	-
46	L	- [With climate controlled seat]
46	BG	- [With heated seat]
47	G	- [With climate controlled seat]
47	GR	- [With heated seat]
48	V	-
49	BG	-
50	LG	-
51	SB	-
52	Y	-
53	W	-
56	B	-
57	G	-
58	R	-
59	W	-
61	LG	-
82	V	-
63	R	-
66	L	-
67	Y	-
68	SB	-
69	B	-
70	R	-
76	SHIELD	-
77	G	-
78	R	-
79	L	-
80	G	-
81	BG	-
82	BR	-
83	GR	-
84	V	-
85	LG	-
86	V	-
87	R	-
88	Y	-
89	BR	-
90	L	-
91	Y	-
93	W	- [With climate controlled seat]
93	G	- [With heated seat]
94	V	-

CONNECTOR INFORMATION

< WIRING DIAGRAM >

MAIN HARNESS

Connector No.	M120
Connector Name	BCM (BODY CONTROL MODULE)
Connector Type	TH40FB-NH



1	2	3	4	5	6	7	8	9	10	11	12	13	14	15	16	17	18	19	20
21	22	23	24	25	26	27	28	29	30	31	32	33	34	35	36	37	38	39	40

Terminal No.	Color of Wire	Signal Name [Specification]
1	G	RR WINDOW DEFG RLY CONT
2	BG	COMBI SW INPUT 5
3	SB	COMBI SW INPUT 4
4	L	COMBI SW INPUT 3
5	G	COMBI SW INPUT 2
6	P	COMBI SW INPUT 1
8	V	POWER WINDOW SW COMM
9	P	STOP LAMP SW 1
11	R	PAIN SENSOR SERIAL LINK
14	W	OPTICAL SENSOR
16	SB	DIMMER SIGNAL
17	Y	SENSOR PWR SPLY
18	B	RECEIVER / SENSOR GND
19	R	RECEIVER PWR SPLY
20	BR	KYLS ENT RECEIVER COMM
21	P	NATS ANT AMP
22	GR	KYLS ENT RECEIVER RSSI
23	G	SECURITY IND CONT
24	L	DONGLE LINK
25	G	NATS ANT AMP
26	G	I-KEY IDENTIFICATION
29	G	HAZARD SW
30	O	TR LID OPNR SW
31	W	DR DOOR UNLK SENSOR
32	BR	COMBI SW OUTPUT 5
33	R	COMBI SW OUTPUT 4
34	V	COMBI SW OUTPUT 3
35	Y	COMBI SW OUTPUT 2
36	LG	COMBI SW OUTPUT 1
37	R	P POSITION
39	L	CAN-H
40	P	CAN-L

Connector No.	M121
Connector Name	BCM (BODY CONTROL MODULE)
Connector Type	FE40FB-FH4G-SA



41	42	43	44	45	46	47	48	49	50	51	52	53	54	55
----	----	----	----	----	----	----	----	----	----	----	----	----	----	----

Terminal No.	Color of Wire	Signal Name [Specification]
41	W	TR KEY CYLINDER SW
42	R	TRUNK LID OPEN/CLOSE STATUS
44	V	TR LID OP CANCEL SW
45	GR	PASSENGER DOOR SW
46	BR	REAR RH DOOR SW
47	LG	DRIVER DOOR SW
48	P	REAR LH DOOR SW
49	SB	TR ROOM LAMP CONT
51	BG	TR LID OPEN REQ SW
53	LG	TRUNK LID OPEN REQUEST
55	BR	RR DOOR UNLK OUTPUT

Connector No.	M122
Connector Name	BCM (BODY CONTROL MODULE)
Connector Type	FE40FB-FH4G-SA



56	57	58	59	60	61	62	63	64	65	66	67	68	69	70
----	----	----	----	----	----	----	----	----	----	----	----	----	----	----

Terminal No.	Color of Wire	Signal Name [Specification]
56	R	INT ROOM LAMP PWR SPLY
57	R	BAT FUSE
58	L	SENS CANCEL SW
59	G	PASS DOOR UNLK OUTPUT
60	G	TURN SIG LH OUTPUT
61	V	TURN SIG RH OUTPUT
62	V	STEP LAMP CONT
63	L	ROOM LAMP TIMER CONT
64	V	ALL DOOR FL LID LOCK OUTPUT
66	LG	DR DOOR FL LID UNLK OUTPUT
67	B	GND

68	O	PW PWR SPLY (IGN)
69	Y	PW PWR SPLY (BAT)
70	W	BAT (F/L)

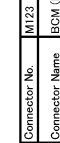

Connector No.	M123
Connector Name	BCM (BODY CONTROL MODULE)
Connector Type	TH40FW-NH

71	72	73	74	75	76	77	78	79	80	81	82	83	84	85	86	87	88	89	90
91	92	93	94	95	96	97	98	99	100	101	102	103	104	105	106	107	108	109	110

Terminal No.	Color of Wire	Signal Name [Specification]
72	B	OUTJS HD LAMP OUTPUT
73	V	ON IND
74	G	DR DOOR REG SW
76	BR	PUSH SW
78	BR	DRIVER DOOR ANTI+
79	SB	DRIVER DOOR ANTI-
80	LG	PASSENGER DOOR ANTI+
81	V	PASSENGER DOOR ANTI-
82	V	REAR BMPR ANTI+
83	SB	REAR BMPR ANTI-
84	BR	ROOM ANTI+
85	Y	ROOM ANTI-
86	R	ROOM ANTI2+
87	G	ROOM ANTI2-
88	V	TRUNK ROOM ANTI+
89	SB	TRUNK ROOM ANTI-
90	R	PUSH-BTN IGN SW ILL PWR
91	GR	LOCK IND
92	B	PUSH-BTN IGN SW ILL GND
93	V	I-KEY WARN BUZZER
96	SB	ACC RELAY CONT
97	SB	STARTER RELAY CONT
98	B	IGN RELAY (P/WR) CONT
99	R	IGN RELAY (F/B) CONT
100	SB	PASS DOOR REG SW
102	BR	P/N POSITION
104	GR	A/T SHIFT SELECT PWR SPLY
105	R	STOP LAMP SW 2
106	B	BLWR RELAY CONT
109	Y	ACC IND

Connector No.	M125
Connector Name	CAN GATEWAY
Connector Type	TH12FW-NH



1	2	3	4	5	6	7	8	9	10	11	12
---	---	---	---	---	---	---	---	---	----	----	----

Terminal No.	Color of Wire	Signal Name [Specification]
1	L	CAN-H
3	GR	BATTERY
4	L	CAN-H
5	B	GND
6	L	CAN-H
7	P	CAN-L
9	W	IGNITION
10	P	CAN-L
11	B	GND
12	P	CAN-L

Connector No.	M130
Connector Name	NATS ANTENNA AMP.
Connector Type	TH04FW-NH



1	2	3	4
---	---	---	---

Terminal No.	Color of Wire	Signal Name [Specification]
1	L	BAT
2	P	CLK
3	G	DATA
4	B	GND

JRMWC9585GB

A B C D E F G H I J K L N O P PG

CONNECTOR INFORMATION

< WIRING DIAGRAM >

MAIN HARNESS

Connector No.	M131
Connector Name	INSIDE KEY ANTENNA (INSTRUMENT CENTER)
Connector Type	PK02FL



Terminal No.	Color of Wire	Signal Name [Specification]
1	BR	ANT+
2	Y	ANT-

Connector No.	M132
Connector Name	CIGARETTE LIGHTER SOCKET
Connector Type	NS03FW-CS



Terminal No.	Color of Wire	Signal Name [Specification]
1	B	-
2	R	-
3	Y	-

Connector No.	M134
Connector Name	OPTION CONNECTOR
Connector Type	TH08FW-NH



Terminal No.	Color of Wire	Signal Name [Specification]
1	BG	-

2	W	-
3	L	-
5	P	-
6	B	-
7	LG	-
8	GR	-

Connector No.	M135
Connector Name	WIRE TO WIRE
Connector Type	TH02FW-NH



Terminal No.	Color of Wire	Signal Name [Specification]
1	W	-
2	BG	-
5	V	- [With climate controlled seat]
6	P	- [With heated seat]
7	SB	- [With climate controlled seat]
10	G	- [With climate controlled seat]
11	R	- [With heated seat]
12	L	- [With 4WAS]
13	W	- [With climate controlled seat]
14	L	-
15	G	-
16	Y	-
17	W	- [With climate controlled seat]
18	BR	- [With heated seat]
19	GR	-
20	B	-
21	GR	- [With 4WAS]
22	W	- [Without 4WAS]
23	B	- [With climate controlled seat]
24	BG	-
25	LG	- [With climate controlled seat]
32	B	- [With heated seat]

26	SB	- [With climate controlled seat]
27	R	- [With heated seat]
28	P	- [With climate controlled seat]
29	B	- [With heated seat]
30	B	-
32	V	-
33	L	-

Connector No.	M137
Connector Name	A/T SHIFT SELECTOR
Connector Type	TK10FW



Terminal No.	Color of Wire	Signal Name [Specification]
1	W	-
2	V	-
3	L	-
4	B	-
5	G	-
6	SB	-
7	GR	-
8	R	-

Connector No.	M143
Connector Name	YAW RATE / SIDE / DESEL G SENSOR
Connector Type	SAZ09FB

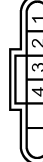

Terminal No.	Color of Wire	Signal Name [Specification]
1	B	-
2	R	- [Except for Federal with 2WH sport advanced technology]
3	Y	- [For Federal with 2WH sport advanced technology]
4	L	- [Except for Federal with 2WH sport advanced technology]

3	SB	- [For Federal with 2WH sport advanced technology]
4	G	-

Connector No.	M146
Connector Name	INSIDE KEY ANTENNA (CONSOLE)
Connector Type	PK02FL



Terminal No.	Color of Wire	Signal Name [Specification]
1	R	ANT+
2	G	ANT-

CONNECTOR INFORMATION

< WIRING DIAGRAM >

MAIN HARNESS

Connector No.	M147
Connector Name	AIR BAG DIAGNOSIS SENSOR UNIT
Connector Type	M128FY-EX

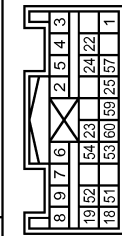

Terminal No.	Color of Wire	Signal Name [Specification]
1	LG	IGN
2	B	GND
3	Y	DRI (+)
4	Y	DRI (-) DRZ (-)
5	Y	DRZ (+)
6	Y	ASI (+)
7	Y	ASI (-)
8	Y	AS2 (+)
9	Y	AS2 (-)
10	SB	ECZS (+)
11	V	ECZS (-)
12	SHIELD	GND
13	R	AIR BAG W/L
14	G	SEAT BELT
15	R	CUTOFF TELLTALE
16	G	SATELLITE RH2 (+)
17	R	SATELLITE RH2 (-)
18	P	SATELLITE RH2 (+)
19	L	SATELLITE RH2 (-)
20	L	IVCS
21	L	CAN-H
22	P	CAN-L

Connector No.	M148
Connector Name	CONSOLE POWER SOCKET
Connector Type	P02FB-Z

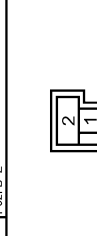

Terminal No.	Color of Wire	Signal Name [Specification]
2		
1		

1	Y	-
2	B	-

Connector No.	M150
Connector Name	WIRE TO WIRE
Connector Type	RH12FB

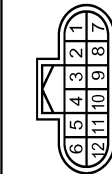

Terminal No.	Color of Wire	Signal Name [Specification]
1	Y	-
2	BR	-
3	R	-
4	L	-
5	W	-
6	G	-
7	BG	-
8	LG	-
9	G	-
10	Y	-
11	L	-
12	SHIELD	-

Connector No.	M151
Connector Name	WIRE TO WIRE
Connector Type	RH12MB

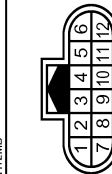

Terminal No.	Color of Wire	Signal Name [Specification]
1	Y	-
2	B	-
3	R	-
4	L	-
5	W	-
6	G	-

7	O	-
8	B	-
9	R	-
10	Y	-
11	L	-
12	SHIELD	-

Connector No.	M152
Connector Name	ACCELERATOR PEDAL ACTUATOR
Connector Type	RH08FLGY

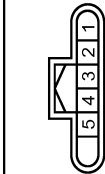

Terminal No.	Color of Wire	Signal Name [Specification]
1	O	BATTERY
2	B	GND
3	R	IGNITION
4	Y	ITS COMM-L
5	L	ITS COMM-H

Connector No.	M153
Connector Name	ACCELERATOR PEDAL POSITION SENSOR
Connector Type	RH08FE

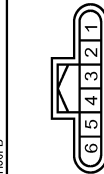

Terminal No.	Color of Wire	Signal Name [Specification]
1	Y	ACCELERATOR PEDAL POSITION SENSOR 2
2	B	SENSOR GROUND
3	L	SENSOR POWER SUPPLY
4	R	ACCELERATOR PEDAL POSITION SENSOR 1
5	W	SENSOR GROUND
6	G	SENSOR POWER SUPPLY

JRMWC9587GB

A
B
C
D
E
F
G
H
I
J
K
L
PG
N
O
P

CONNECTOR INFORMATION

< WIRING DIAGRAM >

MAIN HARNESS

Connector No.	M100
Connector Name	ECM
Connector Type	MA55F/D-MEB10-L1

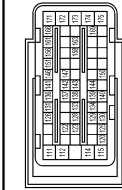

Terminal No.	Color of Wire	Signal Name [Specification]
111	W	FUEL INJECTOR DRIVER POWER SUPPLY
112	W	FUEL INJECTOR DRIVER POWER SUPPLY
114	B	ECM GROUND
115	B	ECM GROUND
120	G	EVAP CANISTER VENT CONTROL VALVE
122	V	VEHICLE START MOTOR RELAY ASBIST SIGNAL VOLT. CONTROL MODULE
123	BG	THROTTLE CONTROL MOTOR RELAY
125	P	FUEL PUMP CONTROL MODULE (FCM)
126	Y	ACCELERATOR PEDAL POSITION SENSOR 2
128	SB	ASC/D STEERING SWITCH
129	BR	SENSOR GROUND [With ICC]
129	B	SENSOR GROUND [Without ICC]
130	Y	SENSOR GROUND
131	L	SENSOR POWER SUPPLY
133	BG	SENSOR POWER SUPPLY
134	P	FUEL TANK TEMPERATURE SENSOR
136	R	ACCELERATOR PEDAL POSITION SENSOR 1
137	G	SENSOR POWER SUPPLY
138	P	BATTERY CURRENT SENSOR
139	BG	BATTERY TEMPERATURE SENSOR
140	W	SENSOR GROUND
141	G	IGNITION SWITCH
142	GR	FUEL PUMP CONTROL MODULE (FCM) CHECK
143	P	FUEL TANK PRESSURE SENSOR
144	LG	REFRIGERANT PRESSURE SENSOR
146	L	CAN COMMUNICATION LINE
147	BR	ASC/D BRAKE SWITCH
150	V	SENSOR GROUND
151	P	CAN COMMUNICATION LINE
156	W	POWER SUPPLY FOR ECM (BACK-UP)
158	P	STOP LAMP SWITCH
161	Y	ENG COMMUNICATION LINE
163	W	ECM RELAY (SELF SHUT-OFF)
166	BG	ENG COMMUNICATION LINE
169	V	ENGINE SPEED SIGNAL OUTPUT
171	SB	POWER SUPPLY FOR ECM
172	SB	POWER SUPPLY FOR ECM
173	R	THROTTLE CONTROL MOTOR POWER SUPPLY

174	B	ECM GROUND
175	B	ECM GROUND

Connector No.	M185
Connector Name	DONGLE UNIT
Connector Type	NS08FBR-CS

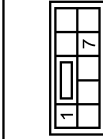

Terminal No.	Color of Wire	Signal Name [Specification]
1	B	GND
7	L	INTERFACE

Connector No.	M181
Connector Name	WIRE TO WIRE
Connector Type	TH40MW-NH



1	2	3	4	5	6	7	8	9	10	11	12	13	14	15	16	17	18	19	20
21	22	23	24	25	26	27	28	29	30	31	32	33	34	35	36	37	38	39	40

Terminal No.	Color of Wire	Signal Name [Specification]
2	R	
3	B	
5	R	
6	BR	
7	L	
8	P	
9	B	
10	W	
11	LG	
12	SB	
14	SB	
15	BR	
16	V	
18	G	
19	B	
20	V	

Connector No.	M183
Connector Name	TRIPLE SWITCH
Connector Type	TH12FB-NH



Terminal No.	Color of Wire	Signal Name [Specification]
1	LG	
2	BR	
3	SS	
3	R	- [Except for Federal with 2WHI sport advanced technology.] - [For Federal with 2WHI sport advanced technology.]
5	B	
6	R	
7	B	
9	W	
11	B	
12	L	

Connector No.	M184
Connector Name	IBA OFF SWITCH
Connector Type	TH408FGY-NH

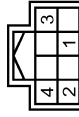

Terminal No.	Color of Wire	Signal Name [Specification]
1	BR	
2	B	
3	R	
4	B	

22	BG	
23	B	
25	W	
27	SB	
29	B	
30	R	
31	BR	
32	L	
33	P	
34	LG	
35	W	
36	LG	
37	L	
38	R	

Connector No.	M182
Connector Name	DATA LINK CONNECTOR
Connector Type	BD18FW

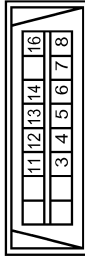

Terminal No.	Color of Wire	Signal Name [Specification]
3	LG	M-CAN-L
4	B	EARTH
5	B	EARTH
6	L	CAN-H
7	V	KLINE
8	LG	IGN SW
11	SB	M-CAN-H
12	P	CAN-L
13	L	CAN-H
14	P	CAN-L
16	W	POWER

JRMWC9588GB

CONNECTOR INFORMATION

< WIRING DIAGRAM >

MAIN HARNESS

Connector No.	M185
Connector Name	IN-VEHICLE SENSOR
Connector Type	TK02FW-ZV



Terminal No.	Color of Wire	Signal Name [Specification]
1	LG	-
2	B	-

Connector No.	M186
Connector Name	FOOT LAMP (DRIVER SIDE)
Connector Type	C02FW



Terminal No.	Color of Wire	Signal Name [Specification]
1	R	-
2	BR	-

Connector No.	M187
Connector Name	TRUNK LID OPENER SWITCH
Connector Type	TH08FB-NH

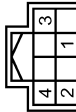

Terminal No.	Color of Wire	Signal Name [Specification]
1	BG	-
2	B	-

3	R	-
4	B	-

Connector No.	M188
Connector Name	TWIN SWITCH
Connector Type	TH12FY-NH

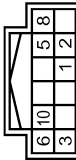

Terminal No.	Color of Wire	Signal Name [Specification]
1	G	-
2	SB	-
3	B	-
5	BG	-
6	B	-
8	W	-
10	B	-

Connector No.	M195
Connector Name	DISPLAY UNIT
Connector Type	TH24FW-NH



Terminal No.	Color of Wire	Signal Name [Specification]
1	B	GND
2	L	INVERTER VCC
3	BG	SIGNAL VCC
4	V	COMPOSITE IMAGE SIGNAL GND
5	SHIELD	SHIELD
6	B	RGB (GREEN) SIGNAL
7	SHIELD	SHIELD
8	G	HP
9	R	RGB AREA (S) SIGNAL
11	BR	COMM (CONT->DISP)
13	LG	INVERTER GND

14	B	SIGNAL GND
15	SB	COMPOSITE IMAGE SIGNAL
17	R	RGB (RED) SIGNAL
18	W	RGB (BLUE) SIGNAL
19	W	RGB SYNC
20	B	VP
21	SHIELD	SHIELD
22	Y	COMM (DISP->CONT)
23	SHIELD	SHIELD

Connector No.	M198
Connector Name	HEATED SEAT SWITCH (DRIVER SIDE)
Connector Type	TK10FW



Terminal No.	Color of Wire	Signal Name [Specification]
1	P	-
2	V	-
3	R	-
4	B	-
5	W	-
6	B	-

Connector No.	M199
Connector Name	HEATED SEAT SWITCH (PASSENGER SIDE)
Connector Type	TK08FB



Terminal No.	Color of Wire	Signal Name [Specification]
1	L	-
2	G	-
3	R	-
4	R	-
5	Y	-

6	B	-
---	---	---

Connector No.	M200
Connector Name	WIRE TO WIRE
Connector Type	TH16FW-NH

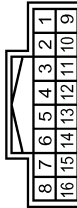

Terminal No.	Color of Wire	Signal Name [Specification]
1	P	-
2	SHIELD	-
3	L	-
4	SHIELD	-
5	G	-
6	R	-
7	B	-
8	W	-
9	SHIELD	-
10	W	-
11	B	-
12	W	-
13	SHIELD	-
14	Y	-
15	O	-
16	BR	-

A
B
C
D
E
F
G
H
I
J
K
L
PG
N
O
P

CONNECTOR INFORMATION

< WIRING DIAGRAM >

MAIN HARNESS

Connector No.	M201
Connector Name	WIRE TO WIRE
Connector Type	TH122MW-NH



Terminal No.	Color of Wire	Signal Name [Specification]
1	Y	-
2	BG	-
5	V	-
6	P	-
7	SB	-
10	G	-
11	R	- [With 4MAS]
11	L	- [Without 4MAS]
12	R	-
13	W	-
14	L	-
15	G	-
16	Y	-
17	W	-
18	BR	-
19	GR	-
20	B	-
21	R	-
22	B	-
23	BG	-
24	V	-
25	B	-
26	R	-
27	B	- [With climate controlled seat]
27	R	- [With heated seat]
28	B	-
28	B	-
30	B	-
32	R	-

Connector No.	M202
Connector Name	A/T SHIFT SELECTOR ILLUMINATION
Connector Type	TK02FBR-B



Terminal No.	Color of Wire	Signal Name [Specification]
1	R	-
2	B	-

Connector No.	M203
Connector Name	DRIVE MODE SELECT SWITCH
Connector Type	TH10FB-NH

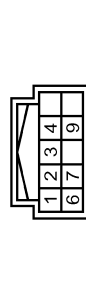

Terminal No.	Color of Wire	Signal Name [Specification]
1	W	-
2	L	-
3	G	-
4	Y	-
6	B	-
7	B	-
9	R	-

Connector No.	M204
Connector Name	CLIMATE CONTROLLED SEAT SWITCH (DRIVER SIDE)
Connector Type	TK10FW

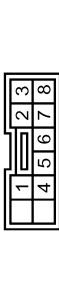

Terminal No.	Color of Wire	Signal Name [Specification]
1	BG	-
2	V	-
3	P	-
4	BR	-
5	GR	-
6	B	-
7	R	-
8	B	-

Connector No.	M205
Connector Name	CLIMATE CONTROLLED SEAT SWITCH (PASSENGER SIDE)
Connector Type	TK08FBR



Terminal No.	Color of Wire	Signal Name [Specification]
1	SB	-
2	G	-
3	L	-
4	BG	-
5	V	-
6	B	-
7	R	-
8	B	-

Connector No.	M206
Connector Name	WIRE TO WIRE
Connector Type	NS308MF-CS



Terminal No.	Color of Wire	Signal Name [Specification]
1	Y	-
2	BG	-
3	V	-
4	SB	-
5	B	-
6	G	-
7	R	-
8	SHIELD	-

Connector No.	M207
Connector Name	WIRE TO WIRE
Connector Type	NS308FW-CS

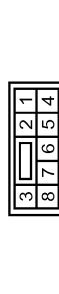

Terminal No.	Color of Wire	Signal Name [Specification]
1	Y	-
2	BG	-
3	SB	-
4	SB	-
5	B	-
6	G	-
7	R	-
8	SHIELD	-

JRMWC9590GB

CONNECTOR INFORMATION

< WIRING DIAGRAM >

MAIN HARNESS

Connector No.	M208
Connector Name	AV CONTROL UNIT
Connector Type	TH18FW-GS2

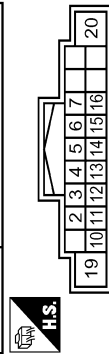

Terminal No.	Color of Wire	Signal Name [Specification]
2	L	SOUND SIGNAL FRONT LH (+)
3	P	SOUND SIGNAL FRONT LH (-)
4	V	SOUND SIGNAL REAR LH (+)
5	LG	SOUND SIGNAL REAR LH (-)
6	P	STRG SW A
7	V	ACC
10	SHIELD	SHIELD
11	G	SOUND SIGNAL FRONT RH (+)
12	R	SOUND SIGNAL FRONT RH (-)
13	BR	SOUND SIGNAL REAR RH (+)
14	GR	SOUND SIGNAL REAR RH (-)
15	B	STRG SW GND
16	L	STRG SW B
19	Y	BATTERY
20	B	GND

Connector No.	M209
Connector Name	AV CONTROL UNIT
Connector Type	TH4UFW-NH

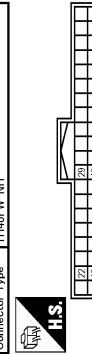

Terminal No.	Color of Wire	Signal Name [Specification]
22	W	CAMERA POWER SUPPLY
29	SB	DISK EJECT SIGNAL
42	B	CAMERA GND
48	BR	SW GND

Connector No.	M210
Connector Name	AV CONTROL UNIT
Connector Type	TH32FW-NH

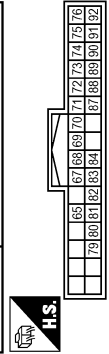

Terminal No.	Color of Wire	Signal Name [Specification]
65	V	PARKING BRAKE SIGNAL
67	R	COMPOSITE IMAGE SIGNAL GND
68	W	COMPOSITE IMAGE SIGNAL
69	G	I-KEY IDENTIFICATION SIGNAL
70	P	-
71	SHIELD	MICROPHONE SHIELD
72	G	MICROPHONE VCC
73	BR	COMM (CONT->DISP) CAN-L
74	P	CAN-L
75	LG	AV COMM (L)
76	LG	AV COMM (R)
79	SB	DIMMER SIGNAL
80	W	IGNITION SIGNAL
81	BG	REVERSE SIGNAL
82	R	VEHICLE SPEED SIGNAL (B-PULSE)
83	SHIELD	SHIELD
84	B	COMPOSITE IMAGE SYNC SIGNAL
87	R	MICROPHONE SIGNAL
88	SHIELD	SHIELD
89	Y	COMM (DISP->CONT)
90	L	CAN-H
91	SB	AV COMM (H)
92	SB	AV COMM (H)

Connector No.	M212
Connector Name	AV CONTROL UNIT
Connector Type	HAA0HFL

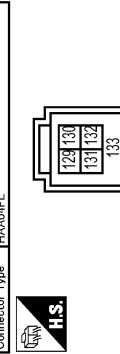

Terminal No.	Color of Wire	Signal Name [Specification]
129	G	USB GND
130	W	V BUS SIGNAL
131	R	USB D- SIGNAL
132	L	USB D+ SIGNAL
133	SHIELD	SHIELD

Connector No.	M213
Connector Name	AV CONTROL UNIT
Connector Type	TH18FW-NH

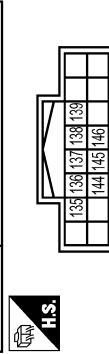

Terminal No.	Color of Wire	Signal Name [Specification]
135	G	VOICE GUIDANCE SIGNAL (+)
136	R	VOICE GUIDANCE SIGNAL (-)
137	SB	SOUND SIGNAL REAR WOOFER +
138	L	SOUND SIGNAL CENTER SPEAKER+
139	B	SHIELD
144	SHIELD	SHIELD
145	Y	SOUND SIGNAL REAR WOOFER-
146	P	SOUND SIGNAL CENTER SPEAKER-

Connector No.	M214
Connector Name	AV CONTROL UNIT
Connector Type	HAA18FGY

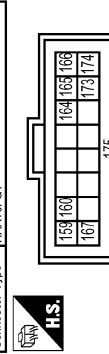

Terminal No.	Color of Wire	Signal Name [Specification]
159	Y	L-VOICE SIGNAL
160	B	VOICE GROUND
164	V	MANUFACTURE SPECIFIC SIGNAL
165	BR	USB V BUS SIGNAL
166	L	USB D- SIGNAL

167	G	D-VOICE SIGNAL
173	B	USB GROUND
174	R	USB D+ SIGNAL
175	SHIELD	SHIELD

Connector No.	M215
Connector Name	DISPLAY UNIT
Connector Type	TH24FW-NH

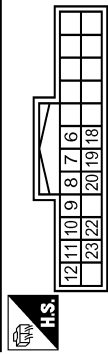

Terminal No.	Color of Wire	Signal Name [Specification]
6	SHIELD	SHIELD
7	SHIELD	SHIELD
8	W	CAMERA IMAGE SIGNAL
9	Y	COMM (DISP->CONT)
10	BR	COMM (CONT->DISP)
11	Y	BATTERY
12	B	GND
18	W	COMPOSITE IMAGE SIGNAL
19	R	COMPOSITE IMAGE GND
20	B	COMPOSITE IMAGE SYNC SIGNAL
22	SHIELD	SHIELD
23	V	ACC

A B C D E F G H I J K L N O P PG

CONNECTOR INFORMATION

< WIRING DIAGRAM >

MAIN HARNESS

Connector No.	M216
Connector Name	TCU
Connector Type	TH40FW-NH1

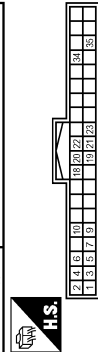

Terminal No.	Color of Wire	Signal Name [Specification]
1	Y	BATTERY POWER SUPPLY
2	B	GROUND
3	SB	ACC POWER SUPPLY
4	W	IGNITION SIGNAL
5	V	ACC OUTPUT
6	P	-
7	B	GROUND
8	L	CAN-H
9	L	CAN-L
10	P	MICROPHONE VCC
18	G	MICROPHONE SIGNAL
19	R	MICROPHONE SHIELD
20	R	MICROPHONE VCC
21	G	MICROPHONE SIGNAL
22	R	MICROPHONE SHIELD
23	S	SOS call switch
34	G	SOS call switch
35	BR	SOS call switch LED signal

Connector No.	M217
Connector Name	TCU
Connector Type	HA1A1RFGY

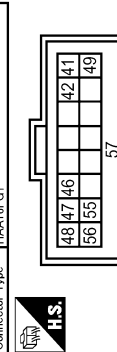

Terminal No.	Color of Wire	Signal Name [Specification]
41	Y	U-VOICE SIGNAL
42	B	VOICE GROUND
46	V	MANUFACTURE SPECIFIC SIGNAL
47	BR	USB V BUS SIGNAL
48	L	USB D- SIGNAL

49	G	D-VOICE SIGNAL
55	B	USB GROUND
56	R	USB D+ SIGNAL
57	SHIELD	SHIELD

Connector No.	M300
Connector Name	4WAS FRONT CONTROL UNIT
Connector Type	TB08FW-TM4

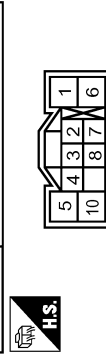

Terminal No.	Color of Wire	Signal Name [Specification]
1	R	FR-MTR (V)
2	LG	FR-ANG SEN SIG (SIN)
3	B	LOCK SOL GND
4	B	FR-ANGL SEN GND
5	L	FR-MTR (U)
6	G	FR-MTR (W)
7	V	FR-ANG SEN SIG (COS)
8	P	FR-ANG SEN SIG (EXCITATION)
10	Y	LOCK SOL PWR SUPPLY

Connector No.	M301
Connector Name	4WAS FRONT ACTUATOR
Connector Type	6098-3458

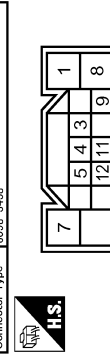

Terminal No.	Color of Wire	Signal Name [Specification]
1	R	-
3	Y	-
4	V	-
5	P	-
7	L	-
8	G	-
9	B	-

11	B	-
12	LG	-

Connector No.	M303
Connector Name	COMBINATION SWITCH (SPIRAL CABLE)
Connector Type	TK08FGY

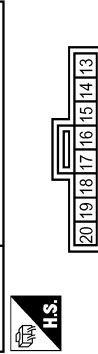

Terminal No.	Color of Wire	Signal Name [Specification]
13	-	-
14	-	-
15	-	-
16	-	-
17	-	-
18	-	-
19	-	-
20	-	-

Connector No.	M304
Connector Name	A/C AUTO AMP.
Connector Type	TH40FT-NH

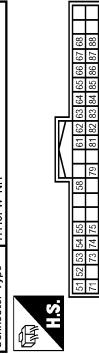

Terminal No.	Color of Wire	Signal Name [Specification]
51	B	INTAKE SENSOR SIGNAL
52	W/R	AROMA MOTOR PBR F/B SIGNAL
53	G	AR MIX DOOR MOTOR (DR) PBR F/B SIGNAL
54	P	MODE DOOR MOTOR (DR) PBR F/B SIGNAL
55	L/B	INTAKE DOOR MOTOR PBR F/B SIGNAL
58	P/B	RR MODE DOOR MOTOR PBR F/B SIGNAL
61	BR	AR MIX DOOR MOTOR (DR) COOL DRIVE SIGNAL
62	G/R	AROMA MOTOR (FRAGRANT WOOD) DRIVE SIGNAL
83	V	MODE DOOR MOTOR (DR) VENT DRIVE SIGNAL
84	R/B	MODE DOOR MOTOR/PASS VENT DRIVE SIGNAL

65	L/R	INTAKE DOOR MOTOR REC DRIVE SIGNAL
66	BP/B	UP VENT DOOR MOTOR CLOSE DRIVE SIGNAL
67	LG	AR MIX DOOR MOTOR (PASS) HOT DRIVE SIGNAL
68	R/W	RR MODE DOOR MOTOR VENT DRIVE SIGNAL
71	R	EACH DOOR MOTOR PBR POWER SUPPLY
73	SB	MODE DOOR MOTOR (PASS) PBR F/B SIGNAL
74	L	AR MIX DOOR MOTOR (PASS) PBR F/B SIGNAL
75	G/B	UP VENT DOOR MOTOR PBR F/B SIGNAL
79	W	INTAKE SENSOR GROUND / EACH DOOR MOTOR PBR GROUND
81	Y	AR MIX DOOR MOTOR (DR) HOT DRIVE SIGNAL
82	LG/R	AROMA MOTOR (LEAF SCENT) DRIVE SIGNAL
83	B	MODE DOOR MOTOR (DR) DEF DRIVE SIGNAL
84	W/B	MODE DOOR MOTOR (PASS) DEF DRIVE SIGNAL
85	LG/B	INTAKE DOOR MOTOR FRE DRIVE SIGNAL
86	Y/B	UP VENT DOOR MOTOR OPEN DRIVE SIGNAL
87	GR	AR MIX DOOR MOTOR (PASS) COOL DRIVE SIGNAL
88	B/W	RR MODE DOOR MOTOR FOOT DRIVE SIGNAL

Connector No.	M305
Connector Name	AROMA MOTOR
Connector Type	-

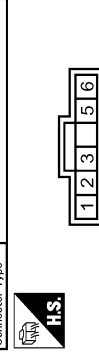



Terminal No.	Color of Wire	Signal Name [Specification]
1	W	-
2	W/R	-
3	R	-
5	LG/R	-
6	GR	-

CONNECTOR INFORMATION

< WIRING DIAGRAM >



MAIN HARNESS

Connector No.	M306
Connector Name	AIR MIX DOOR MOTOR RH
Connector Type	-



Terminal No.	Color of Wire	Signal Name [Specification]
1	LG	-
2	GR	-
3	L	-
5	W	-
7	R	-

Connector No.	M307
Connector Name	MODE DOOR MOTOR RH
Connector Type	-



Terminal No.	Color of Wire	Signal Name [Specification]
1	R/B	-
2	W/B	-
3	SB	-
4	R	-
5	W	-

Connector No.	M308
Connector Name	MODE DOOR MOTOR RH
Connector Type	-



Terminal No.	Color of Wire	Signal Name [Specification]
1	R/B	-
2	W/B	-
3	SB	-
5	R	-
7	W	-

Connector No.	M309
Connector Name	INTAKE DOOR MOTOR
Connector Type	-

Terminal No.	Color of Wire	Signal Name [Specification]
1	L/R	-
2	LG/B	-
3	L/B	-
4	R	-
5	W	-

Connector No.	M310
Connector Name	INTAKE DOOR MOTOR
Connector Type	-



Terminal No.	Color of Wire	Signal Name [Specification]
1	L/R	-
2	LG/B	-
3	L/B	-
5	R	-
7	W	-

Connector No.	M312
Connector Name	UPPER VENTILATOR DOOR MOTOR
Connector Type	-





Terminal No.	Color of Wire	Signal Name [Specification]
1	BR/B	-
2	Y/B	-
3	G/B	-
5	W	-
7	R	-

Connector No.	M313
Connector Name	UPPER VENTILATOR DOOR MOTOR
Connector Type	-

Terminal No.	Color of Wire	Signal Name [Specification]
1	BR/B	-
2	Y/B	-
3	G/B	-
4	W	-
5	R	-

Connector No.	M314
Connector Name	INTAKE SENSOR
Connector Type	-

Terminal No.	Color of Wire	Signal Name [Specification]
1	W	-
2	B	-

JRMWC9593GB

A
B
C
D
E
F
G
H
I
J
K
L
N
O
P

PG

CONNECTOR INFORMATION

< WIRING DIAGRAM >

MAIN HARNESS

Connector No.	M315
Connector Name	AIR MIX DOOR MOTOR LH
Connector Type	-



Terminal No.	Color of Wire	Signal Name [Specification]
1	Y	-
2	BR	-
3	G	-
5	W	-
7	R	-

Connector No.	M316
Connector Name	MODE DOOR MOTOR LH
Connector Type	-



Terminal No.	Color of Wire	Signal Name [Specification]
1	V	-
2	B	-
3	P	-
4	R	-
5	W	-

Connector No.	M317
Connector Name	MODE DOOR MOTOR LH
Connector Type	-



Terminal No.	Color of Wire	Signal Name [Specification]
1	V	-
2	B	-
3	P	-
5	R	-
7	W	-

Connector No.	M318
Connector Name	REAR MODE DOOR MOTOR
Connector Type	-



Terminal No.	Color of Wire	Signal Name [Specification]
1	R/W	-
2	B/W	-
3	P/B	-
5	R	-
7	W	-

Connector No.	M319
Connector Name	COMBINATION SWITCH (SPIRAL CABLE)
Connector Type	ACA02FY-2V



Terminal No.	Color of Wire	Signal Name [Specification]
10	-	-
11	-	-

Connector No.	M320
Connector Name	COMBINATION SWITCH (SPIRAL CABLE)
Connector Type	ACA02FOR



Terminal No.	Color of Wire	Signal Name [Specification]
9	-	-
12	-	-

Connector No.	M393
Connector Name	AV CONTROL UNIT
Connector Type	GT13SH-2/1S-HU



Terminal No.	Color of Wire	Signal Name [Specification]
137	-	ANTENNA AMP-ON SIGNAL
138	-	AM-FM MAIN

Connector No.	M394
Connector Name	AV CONTROL UNIT
Connector Type	GT13SH-2/1S-HU

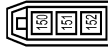

Terminal No.	Color of Wire	Signal Name [Specification]
150	-	ANTENNA AMP-ON SIGNAL
151	-	AM-FM MAIN
152	-	FM SUBJ

Connector No.	M395
Connector Name	AV CONTROL UNIT
Connector Type	GT5-1S-HU



Terminal No.	Color of Wire	Signal Name [Specification]
153	-	GPS ANTENNA
154	-	SHIELD

JRMWC9594.GB

CONNECTOR INFORMATION

< WIRING DIAGRAM >

MAIN HARNESS

Connector No.	M417
Connector Name	WIRE TO WIRE
Connector Type	GT16C-1S-HU



Terminal No.	Color of Wire	Signal Name [Specification]
1	-	-
2	SHIELD	-

Connector No.	M418
Connector Name	WIRE TO WIRE
Connector Type	GT16C-1PP-HU



Terminal No.	Color of Wire	Signal Name [Specification]
1	-	-
2	SHIELD	-

Connector No.	M419
Connector Name	SATELLITE RADIO ANTENNA
Connector Type	GT16C-1PP-HU



Terminal No.	Color of Wire	Signal Name [Specification]
1	-	-
2	SHIELD	-

JRMWC9596GB

CONNECTOR INFORMATION

< WIRING DIAGRAM >

R Room Lamp Harness

INFOID:000000008131350

ROOM LAMP HARNESS

Connector No.	R1
Connector Name	WIRE TO WIRE
Connector Type	NS28FW-CS



Terminal No.	Color of Wire	Signal Name [Specification]
1	B	-
2	R	-
3	R	-
4	BG	-
5	Y	-
6	GR	-
7	B	-
8	BR	-

Connector No.	R2
Connector Name	WIRE TO WIRE
Connector Type	TH24MW-NH

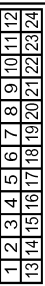

Terminal No.	Color of Wire	Signal Name [Specification]
2	G	-
5	SHIELD	-
6	R	-
7	G	-
8	B	-
9	B	-
10	P	-
11	BR	-
12	R	-
13	BR	-
14	V	-
17	LG	-
18	L	-
19	G	-
20	R	-

21	R	-
22	B	-
23	GR	-
24	P	-



Connector No.	R3
Connector Name	AUTO ANTI-DAZZLING INSIDE MIRROR
Connector Type	SAC10FB

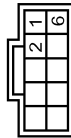

Terminal No.	Color of Wire	Signal Name [Specification]
1	R	IGN
2	B	GRD
6	G	BAT

Connector No.	R4
Connector Name	SUNROOF MOTOR ASSEMBLY
Connector Type	YEA10FGY



Terminal No.	Color of Wire	Signal Name [Specification]
1	B	GRD
3	BG	TIMER (+IGN)
5	P	SW-BITD
6	Y	+B
8	GR	SPEED SENSOR (8P)
10	GR	SW-BIT1

Connector No.	R5
Connector Name	WIRE TO WIRE
Connector Type	AG3MW

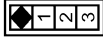

Terminal No.	Color of Wire	Signal Name [Specification]
1	G	-
2	R	-
3	SHIELD	-

Connector No.	R6
Connector Name	HUMIDITY SENSOR
Connector Type	JA06FW



Terminal No.	Color of Wire	Signal Name [Specification]
1	B	-
2	R	-
3	W	-
4	Y	-
5	LG	-
6	L	-

Connector No.	R7
Connector Name	WIRE TO WIRE
Connector Type	TH24FW-NH



Terminal No.	Color of Wire	Signal Name [Specification]
1	G	-
2	Y	-
3	W	-
4	R	-
7	R	-
8	P	-
9	B	-
10	V	-
11	BR	-
12	G	-
13	L	-
14	L	-
15	LG	-
16	Y	-
17	W	-
18	R	-
19	B	-
20	R	-
21	R	-
22	G	-
23	L	-
24	LG	-

A
B
C
D
E
F
G
H
I
J
K
L
N
O
P

PG

JRMWC8597GB

CONNECTOR INFORMATION

< WIRING DIAGRAM >

ROOM LAMP HARNESS

Connector No.	R8
Connector Name	LANE CAMERA UNIT
Connector Type	TH08FW-NH

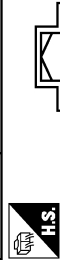

Terminal No.	Color of Wire	Signal Name [Specification]
1	B	GND
4	L	ITS COMM-H
5	B	GND
7	G	IGNITION
8	Y	ITS COMM-L

Connector No.	R9
Connector Name	RAIN SENSOR
Connector Type	AA030FB

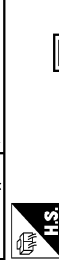

Terminal No.	Color of Wire	Signal Name [Specification]
1	W	+B
2	R	SIC
3	B	GND

Connector No.	R11
Connector Name	WIRE TO WIRE
Connector Type	TH24FW-NH

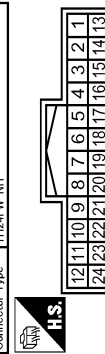

Terminal No.	Color of Wire	Signal Name [Specification]
2	G	
5	SHIELD	
6	R	
7	G	
8	B	
9	B	
10	R	
11	BR	
12	R	
13	BR	
14	V	
17	L	
18	LG	
19	R	
20	G	
21	R	
22	B	
23	GR	
24	P	

Connector No.	R12
Connector Name	VANITY MIRROR LAMP (DRIVER SIDE)
Connector Type	MCA02FW



Terminal No.	Color of Wire	Signal Name [Specification]
1	B	
2	V	

Connector No.	R13
Connector Name	VANITY MIRROR LAMP (PASSENGER SIDE)
Connector Type	MCA02FW



Terminal No.	Color of Wire	Signal Name [Specification]
1	B	
2	V	

Connector No.	R14
Connector Name	PERSONAL LAMP
Connector Type	TH04FW-NH

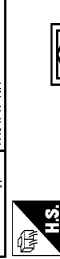

Terminal No.	Color of Wire	Signal Name [Specification]
1	V	
2	B	
3	Y	

Connector No.	R15
Connector Name	MAP LAMP
Connector Type	TK08FCY



Terminal No.	Color of Wire	Signal Name [Specification]
1	V	

2	SB
3	B
4	Y
5	B/Y
6	G

Connector No.	R16
Connector Name	SUNROOF SWITCH
Connector Type	TH08FW-NH

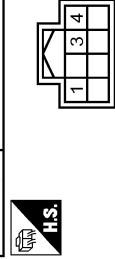

Terminal No.	Color of Wire	Signal Name [Specification]
1	O	
3	L/B	
4	W/R	

Connector No.	R17
Connector Name	MICROPHONE
Connector Type	TK04FW

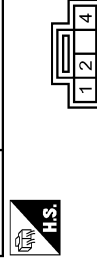

Terminal No.	Color of Wire	Signal Name [Specification]
1	L	
2	SHIELD	
4	R	

JRMWC9598GB

CONNECTOR INFORMATION

< WIRING DIAGRAM >

ROOM LAMP HARNESS

Connector No.	R18
Connector Name	FRONT MICROPHONE (ACTIVE NOISE CONTROL)
Connector Type	TH04FW-NH



Terminal No.	Color of Wire	Signal Name [Specification]
1	LG	-
2	W	-
3	B	-
4	P	-

Connector No.	R19
Connector Name	FRONT MICROPHONE (ACTIVE NOISE CONTROL)
Connector Type	TK02FBR



Terminal No.	Color of Wire	Signal Name [Specification]
1	W	-
2	LG	-

Connector No.	R20
Connector Name	REAR MICROPHONE (ACTIVE NOISE CONTROL)
Connector Type	TH04FW-NH



Terminal No.	Color of Wire	Signal Name [Specification]
--------------	---------------	-----------------------------

1	BR	-
2	GR	-
3	B	-
4	P	-

Connector No.	R21
Connector Name	REAR MICROPHONE (ACTIVE NOISE CONTROL)
Connector Type	TK02FBR



Terminal No.	Color of Wire	Signal Name [Specification]
1	GR	-
2	BR	-

Connector No.	R22
Connector Name	TELEMATICS SWITCH
Connector Type	TH08FW-NH

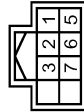

Terminal No.	Color of Wire	Signal Name [Specification]
1	V	-
2	BR	-
3	G	-
5	SB	-
6	B	-
7	B	-

JRMWC9599GB

A
B
C
D
E
F
G
H
I
J
K
L
N
O
P

PG

CONNECTOR INFORMATION

< WIRING DIAGRAM >

T Tail Harness

INFOID:000000008131351

TAIL HARNESS

Connector No.	T2
Connector Name	BACK-UP LAMP LH
Connector Type	HS2FG



Terminal No.	Color of Wire	Signal Name [Specification]
1	O	-
2	L	-

Connector No.	T4
Connector Name	TRUNK LID OPENER REQUEST SWITCH
Connector Type	TK02NBR-P



Terminal No.	Color of Wire	Signal Name [Specification]
1	P	-
2	L	-

Connector No.	T5
Connector Name	REAR VIEW CAMERA
Connector Type	TH0ANW-RH



Terminal No.	Color of Wire	Signal Name [Specification]
1	W	CAMERA POWER SUPPLY
2	B	CAMERA GND

3	R	CAMERA IMAGE SIGNAL
---	---	---------------------

Connector No.	T6
Connector Name	TRUNK KEY CYLINDER SWITCH
Connector Type	TK03FW



Terminal No.	Color of Wire	Signal Name [Specification]
1	L	-
2	W	-

Connector No.	T7
Connector Name	BACK-UP LAMP RH
Connector Type	HS2FG



Terminal No.	Color of Wire	Signal Name [Specification]
1	O	-
2	L	-

Connector No.	T8
Connector Name	LICENSE PLATE LAMP RH
Connector Type	G02FW



Terminal No.	Color of Wire	Signal Name [Specification]
1	V	-
2	L	-

Connector No.	T9
Connector Name	LICENSE PLATE LAMP LH
Connector Type	G02FW



Terminal No.	Color of Wire	Signal Name [Specification]
1	V	-
2	L	-

Connector No.	T13
Connector Name	WIRE TO WIRE
Connector Type	NS18FW-CS

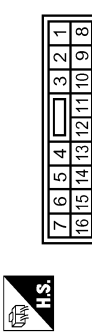

Terminal No.	Color of Wire	Signal Name [Specification]
1	Y	-
2	G	-
3	P	-
5	W	-
6	R	-
8	O	-
9	V	-
10	L	-
11	W	-
12	B	-
13	R	-
14	L	-
15	P	-

Connector No.	T14
Connector Name	TRUNK CLOSURE CONTROL UNIT
Connector Type	NS08FW-CS



Terminal No.	Color of Wire	Signal Name [Specification]
1	G	-
2	L	-
3	L	-
4	P	-
5	Y	-
6	R	-

BATTERY INSPECTION

< BASIC INSPECTION >

BASIC INSPECTION

BATTERY INSPECTION

How to Handle Battery

INFOID:000000008131352

CAUTION:

- If it becomes necessary to start the engine with a booster battery and jumper cables, use a 12-volt booster battery.
- After connecting battery cables, ensure that they are tightly clamped to battery terminals for good contact.
- Never add distilled water through the hole used to check specific gravity.

METHODS OF PREVENTING OVER-DISCHARGE

The following precautions must be taken to prevent over-discharging a battery.

- The battery surface (particularly its top) should always be kept clean and dry.
- The terminal connections should be clean and tight.
- At every routine maintenance, check the electrolyte level.
This also applies to batteries designated as "low maintenance" and "maintenance-free".

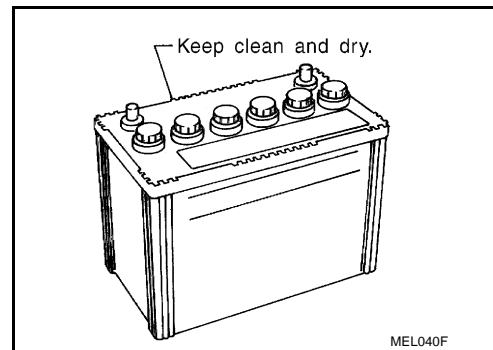

- When the vehicle is not going to be used over a long period of time, disconnect the battery cable from the negative terminal. (If the vehicle has an extended storage switch, turn it off.)

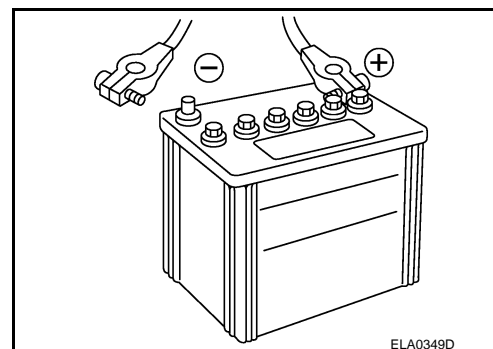

Work Flow

INFOID:000000008131353

BATTERY DIAGNOSIS WITH EXP-800 NI OR GR8-1200 NI

To diagnose and confirm the condition of the battery, use the following special service tools:

- EXP-800 NI Battery and electrical diagnostic analyzer
- GR8-1200 NI Multitasking battery and electrical diagnostic station

NOTE:

Refer to the applicable instruction manual for proper battery diagnosis procedures.

BATTERY DIAGNOSIS WITHOUT EXP-800 NI OR GR8-1200 NI

Check Electrolyte Level

WARNING:

Never allow battery fluid to come in contact with skin, eyes, fabrics, or painted surfaces. After touching a battery, never touch or rub your eyes until you have thoroughly washed your hands. If acid contacts eyes, skin or clothing, immediately flush with water for 15 minutes and seek medical attention. Failure to do this may cause personal injury or damage to clothing or the painted surfaces.

A
B
C
D
E
F
G
H
I
J
K
L

PG

N
O
P

BATTERY INSPECTION

< BASIC INSPECTION >

- Remove the cell plug using a suitable tool.
- Add distilled water up to the MAX level.

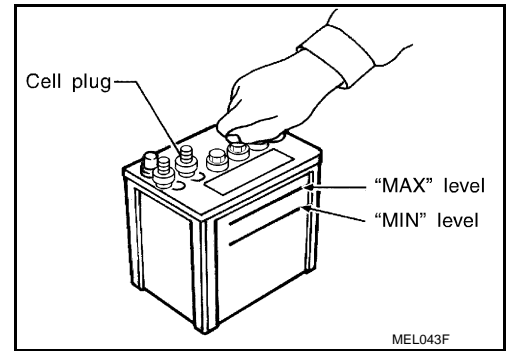

SULPHATION

- A battery will be completely discharged if it is left unattended for a long time and the specific gravity will become less than 1.100. This may result in sulphation on the cell plates.
- To determine if a battery has been “sulphated”, note its voltage and current when charging it. As shown in the figure, less current and higher voltage are observed in the initial stage of charging sulphated batteries.
- A sulphated battery may sometimes be brought back into service by means of a long, slow charge, 12 hours or more, followed by a battery capacity test.

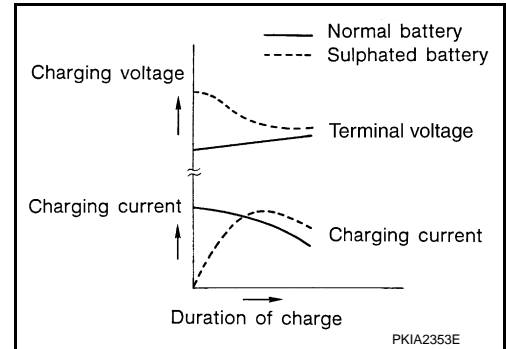

Specific Gravity Check

NOTE:

Check the charge condition of the battery.

Periodically check the specific gravity of the electrolyte. Keep a close check on charge condition to prevent over-discharge.

1. Read hydrometer and thermometer indications at eye level.
2. Use the chart below to correct your hydrometer reading according to electrolyte temperature.

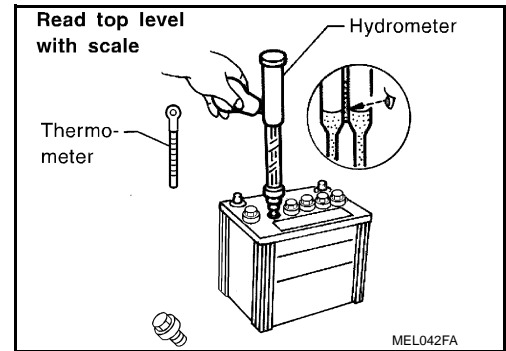

Hydrometer Temperature Correction

Battery electrolyte temperature [°C (°F)]	Add to specific gravity reading
71 (160)	0.032
66 (150)	0.028
60 (140)	0.024
54 (130)	0.020
49 (120)	0.016
43 (110)	0.012
38 (100)	0.008
32 (90)	0.004
27 (80)	0
21 (70)	-0.004
16 (60)	-0.008
10 (50)	-0.012

BATTERY INSPECTION

< BASIC INSPECTION >

Battery electrolyte temperature [°C (°F)]	Add to specific gravity reading
4 (40)	-0.016
-1 (30)	-0.020
-7 (20)	-0.024
-12 (10)	-0.028
-18 (0)	-0.032

Corrected specific gravity	Approximate charge condition
1.260 - 1.280	Fully charged
1.230 - 1.250	3/4 charged
1.200 - 1.220	1/2 charged
1.170 - 1.190	1/4 charged
1.140 - 1.160	Almost discharged
1.110 - 1.130	Completely discharged

Charging The Battery

CAUTION:

- **Never “quick charge” a fully discharged battery.**
- **Keep the battery away from open flame while it is being charged.**
- **When connecting the charger, connect the leads first, then turn on the charger. Never turn on the charger first, as this may cause a spark.**
- **If battery electrolyte temperature rises above 55 °C (131 °F), stop charging. Always charge battery at a temperature below 55 °C (131 °F).**

Charging Rates (Standard Charge)

Approximate charge condition	Charge current (A)	Charge time (h)
Fully charged	7	2
3/4 charged		2.5
1/2 charged		5
1/4 charged		7.5
Almost discharged		9
Completely discharged		10

Charging Rates (Quick Charge)

Approximate charge condition	Charge current (A)	Charge time (h)
Fully charged	—	—
3/4 charged	16	0.5
1/2 charged	33	
1/4 charged		
Almost discharged	—	—
Completely discharged		

NOTE:

The ammeter reading on your battery charger will automatically decrease as the battery charges. This indicates that the voltage of the battery is increasing normally as the state of charge improves. The charging amps indicated above refer to initial charge rate.

- If, after charging, the specific gravity of any two cells varies more than 0.050, the battery should be replaced.

A
B
C
D
E
F
G
H
I
J
K
L
N
O
P

PG

FUSE INSPECTION

< BASIC INSPECTION >

FUSE INSPECTION

How To Check

INFOID:000000008131354

- If fuse is blown, be sure to eliminate cause of malfunction before installing new fuse.
- Use fuse of specified rating. Never use fuse of more than specified rating.
- Do not partially install fuse; always insert it into fuse holder properly.
- Remove fuse for "ELECTRICAL PARTS (BAT)" if vehicle is not used for a long period of time.

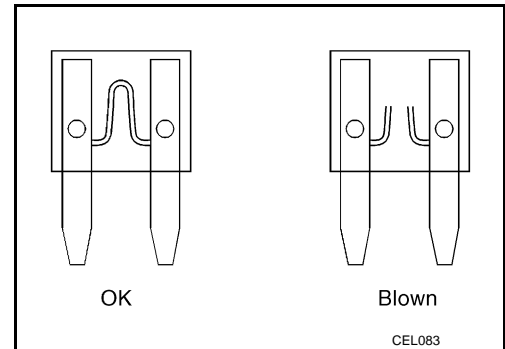

EXTENDED STORAGE SWITCH (IF EQUIPPED)

The following switch may be mounted on the fuse block (Junction Box) for transportation and storage.

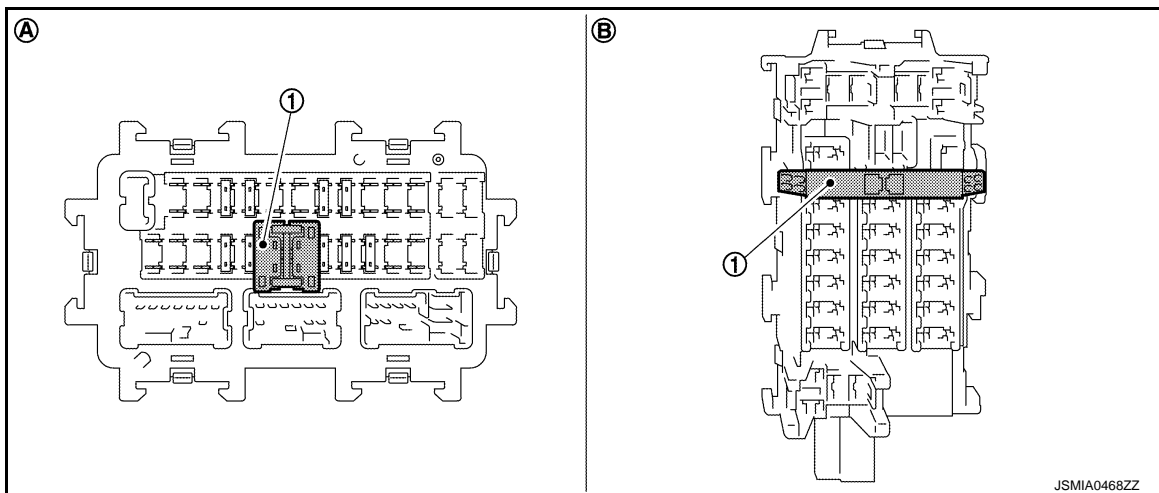

1. Extended storage switch

A. Type A

B. Type B

- Remove the extended storage switch when replacing the fuse of extended storage switch.
- Remove the extended storage switch if it causes the interference when the fuse or the other fuses is checked.

How To Extended Storage Switch ON/OFF

CAUTION:

- Turn the ignition switch OFF when operating the extended storage switch.
- Under normal conditions, keep the extended storage switch in ON state. Never operate the extended storage switch except when necessary.

FUSE INSPECTION

< BASIC INSPECTION >

• Type A

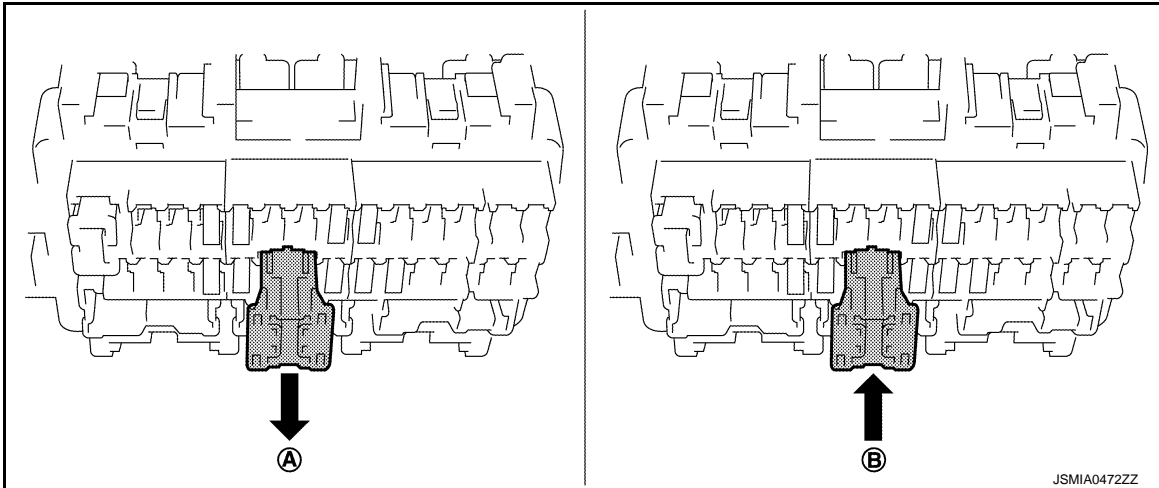

- To turn the extended storage switch OFF, pull it up in (A) direction as shown in the figure.
- To turn the extended storage switch ON, press it in (B) direction as shown in the figure.

• Type B

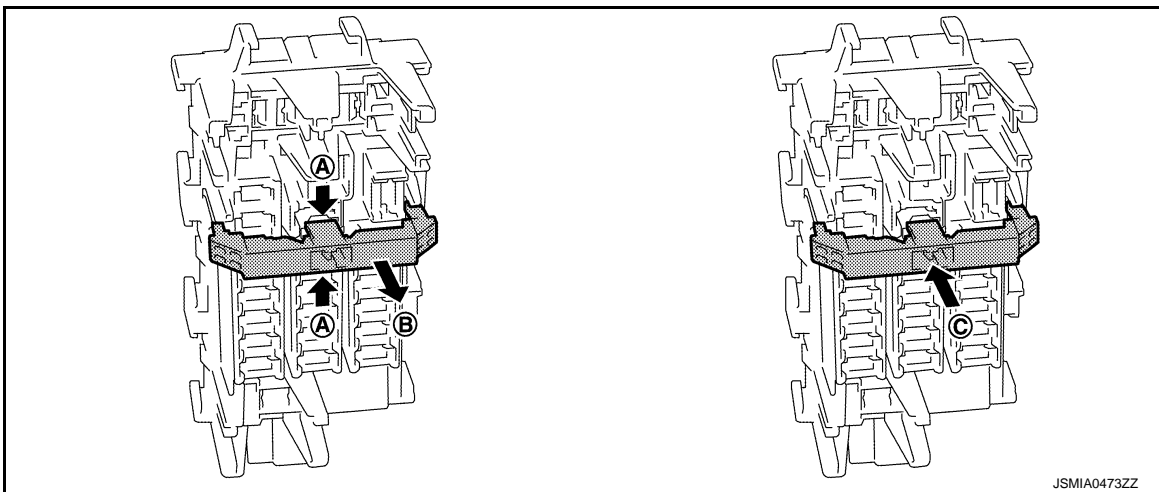

- To turn the extended storage switch OFF, hold (A) of the switch and pull up in (B) direction as shown in the figure.
- To turn the extended storage switch ON, press it in (C) direction as shown in the figure.

How To Remove Extended Storage Switch

Type A

1. Turn the ignition switch OFF.
2. Turn the extended storage switch OFF.
3. Press pawl (A) and tilt to disengage the extended storage switch. Press pawl (B) and tilt to remove the extended storage switch.

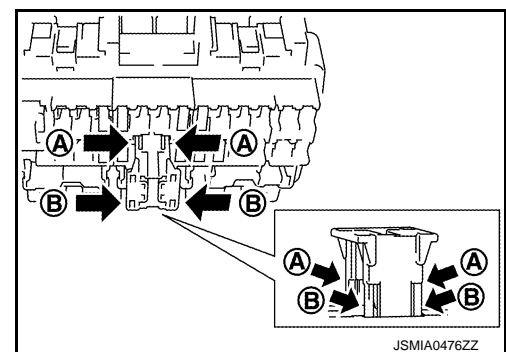

NOTE:

- Extended storage switch and fuse are removed together. Remove fuse from extended storage switch, if necessary.

A
B
C
D
E
F
G
H
I
J
K
L
N
O
P

PG

FUSE INSPECTION

< BASIC INSPECTION >

- Extended storage switch is for transportation and storage. Reinstallation is not required after the removal.

Type B

1. Turn the ignition switch OFF.
2. Turn the extended storage switch OFF.
3. Hold (A) and pull up the extended storage switch hard in (B) direction.

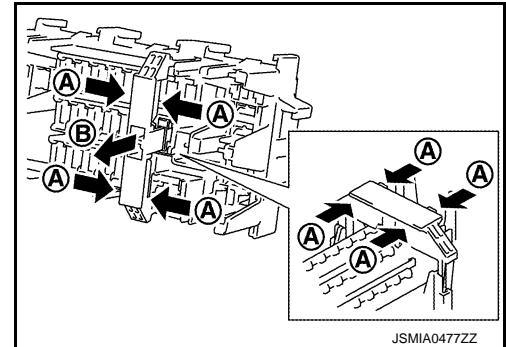

NOTE:

- Extended storage switch and fuse may be removed together. Remove fuse from extended storage switch, if necessary.
- Extended storage switch is for transportation and storage. Reinstallation is not required after the removal.

FUSIBLE LINK INSPECTION

< BASIC INSPECTION >

FUSIBLE LINK INSPECTION

How To Check

INFOID:000000008131355

A melted fusible link can be detected either by visual inspection or by feeling with finger tip. If its condition is questionable, use circuit tester or test lamp.

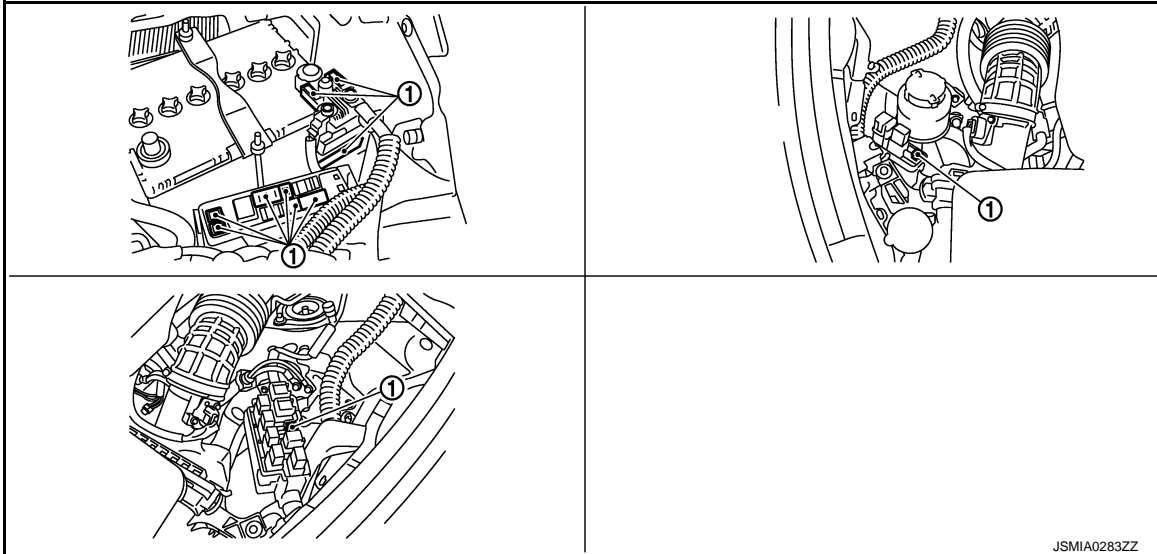

1. Fusible link

CAUTION:

- If fusible link should melt, it is possible that critical circuit (power supply or large current carrying circuit) is shorted. In such a case, carefully check and eliminate cause of malfunction.
- Never wrap outside of fusible link with vinyl tape. Important: Never let fusible link touch any other wiring harness, vinyl or rubber parts.

A
B
C
D
E
F
G
H
I
J
K
L

PG

N
O
P

BATTERY

< REMOVAL AND INSTALLATION >

REMOVAL AND INSTALLATION

BATTERY

Exploded View

INFOID:000000008131356

1 : Battery fix frame

Refer to [GI-3, "Contents"](#) for symbols in the figure.

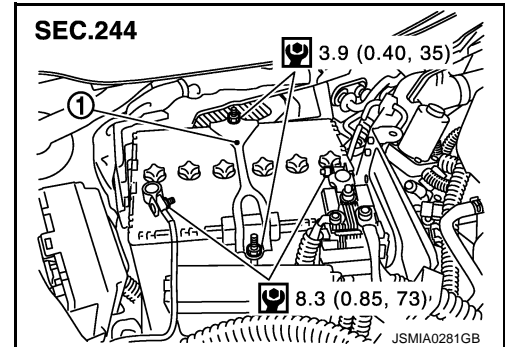

Removal and Installation

INFOID:000000008131357

REMOVAL

1. Remove battery cover.
2. Remove cowl top cover (RH). Refer to [EXT-21, "Exploded View"](#).
3. Remove cover of battery positive terminal.
4. Loosen battery terminal nuts, and disconnect both battery cables from battery terminals.

CAUTION:

When disconnecting, disconnect the battery cable from the negative terminal first.

5. Remove battery fix frame mounting nuts and battery fix frame.
6. Remove battery.

INSTALLATION

Install in the reverse order of removal.

CAUTION:

When connecting, connect the battery cable to the positive terminal first.

Reset electronic systems as necessary. Refer to [GI-58, "ADDITIONAL SERVICE WHEN REMOVING BATTERY NEGATIVE TERMINAL : Required Procedure After Battery Disconnection"](#).

BATTERY TERMINAL WITH FUSIBLE LINK

< REMOVAL AND INSTALLATION >

BATTERY TERMINAL WITH FUSIBLE LINK

Exploded View

INFOID:000000008131358

- 1 : Battery terminal with fusible link
 - 2 : Harness connector
- Refer to [GI-3. "Contents"](#) for symbols in the figure.

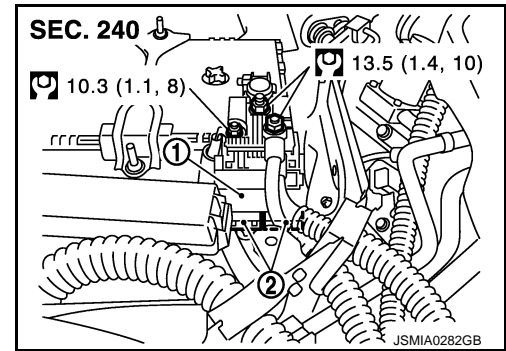

Removal and Installation

INFOID:000000008131359

REMOVAL

1. Remove battery cover.
2. Disconnect the battery cable from the negative terminal.
3. Remove cover of battery positive terminal.
4. Remove harness mounting nuts and battery terminal with fusible link mounting nut.
5. Disconnect harness connector and remove battery terminal with fusible link.

INSTALLATION

Install in the reverse order of removal.

A
B
C
D
E
F
G
H
I
J
K
L
N
O
P

PG

SERVICE DATA AND SPECIFICATIONS (SDS)

< SERVICE DATA AND SPECIFICATIONS (SDS)

SERVICE DATA AND SPECIFICATIONS (SDS)

SERVICE DATA AND SPECIFICATIONS (SDS)

Battery

INFOID:000000008131360

Application	VQ37VHR engine models	VK56VD engine models
Type	110D26L-HR	110D26L-HP
20 hour rate capacity [V - Ah]	12 - 75	12 - 75
Cold cranking current (For reference value) [A]	720	720